

User Manual

Tektronix

**TFS3031 TekRanger
Mini Optical Time-Domain
Reflectometer**

070-9027-04

Copyright © Tektronix, Inc. 1996. All rights reserved.

Tektronix products are covered by U.S. and foreign patents, issued and pending. Information in this publication supercedes that in all previously published material. Specifications and price change privileges reserved.

Printed in the U.S.A.

Tektronix, Inc., P.O. Box 1000, Wilsonville, OR 97070-1000

TEKTRONIX and TEK are registered trademarks of Tektronix, Inc.

WARRANTY

Tektronix warrants that this product will be free from defects in materials and workmanship for a period of one (1) year from the date of shipment. If any such product proves defective during this warranty period, Tektronix, at its option, either will repair the defective product without charge for parts and labor, or will provide a replacement in exchange for the defective product.

In order to obtain service under this warranty, Customer must notify Tektronix of the defect before the expiration of the warranty period and make suitable arrangements for the performance of service. Customer shall be responsible for packaging and shipping the defective product to the service center designated by Tektronix, with shipping charges prepaid. Tektronix shall pay for the return of the product to Customer if the shipment is to a location within the country in which the Tektronix service center is located. Customer shall be responsible for paying all shipping charges, duties, taxes, and any other charges for products returned to any other locations.

This warranty shall not apply to any defect, failure or damage caused by improper use or improper or inadequate maintenance and care. Tektronix shall not be obligated to furnish service under this warranty a) to repair damage resulting from attempts by personnel other than Tektronix representatives to install, repair or service the product; b) to repair damage resulting from improper use or connection to incompatible equipment; or c) to service a product that has been modified or integrated with other products when the effect of such modification or integration increases the time or difficulty of servicing the product.

THIS WARRANTY IS GIVEN BY TEKTRONIX WITH RESPECT TO THIS PRODUCT IN LIEU OF ANY OTHER WARRANTIES, EXPRESSED OR IMPLIED. TEKTRONIX AND ITS VENDORS DISCLAIM ANY IMPLIED WARRANTIES OF MERCHANTABILITY OR FITNESS FOR A PARTICULAR PURPOSE. TEKTRONIX' RESPONSIBILITY TO REPAIR OR REPLACE DEFECTIVE PRODUCTS IS THE SOLE AND EXCLUSIVE REMEDY PROVIDED TO THE CUSTOMER FOR BREACH OF THIS WARRANTY. TEKTRONIX AND ITS VENDORS WILL NOT BE LIABLE FOR ANY INDIRECT, SPECIAL, INCIDENTAL, OR CONSEQUENTIAL DAMAGES IRRESPECTIVE OF WHETHER TEKTRONIX OR THE VENDOR HAS ADVANCE NOTICE OF THE POSSIBILITY OF SUCH DAMAGES.

WARNING

This equipment generates, uses, and can radiate radio-frequency energy, and if not installed and used in accordance with the instructions manual, may cause interference to radio communications. It has been tested and found to comply with the limits for a Class A computing device pursuant to Subpart J of Part 15 of FCC Rules, which are designated to provide reasonable protection against such interference when operated in a commercial environment. Operation of this equipment in a residential area is likely to cause interference, in which case, the user, at his or her own expense, will be required to take whatever measures may be required to correct the interference.



EC Declaration of Conformity

We

Tektronix Holland N.V.
Marktweg 73A
8444 AB Heerenveen
The Netherlands

declare under sole responsibility that the

Tektronix TFS3031 TekRanger (without optional accessories HC411 03 and HC411 03 A1)

meet the intent of Directive 89/336/EEC for Electromagnetic Compatibility. Compliance was demonstrated to the following specifications as listed in the official Journal of the European Communities:

EN 50081-1 Emissions:

EN 55011	Radiated, Class A
EN 55011	Conducted, Class A
EN 60555-2	Power Harmonics

EN 50082-1 Immunity:

IEC 801-2	Electrostatic Discharge
IEC 801-3	RF Radiated
IEC 801-4	Fast Transients
IEC 801-5	Surge

Table of Contents

General Safety Summary	ix
Preface	xiii
If You Need Help	xiii
Before Operating	xiii
Assumptions	xiii
How to Use this Manual	xiv
Service and Warranty	xiv

Section 1. Getting Started

Port Functions	1-1
Laser Output Port and Connector Adapter	1-1
Laser Output Port	1-1
Connector Adapter	1-2
RS232C Serial Port	1-3
Parallel Port	1-3
Keyboard Connector	1-3
Floppy Disk Drive	1-3
Power/Charger Adapter Port	1-4
Buttons and Softkeys	1-7
SELECT Button and Arrow Keys	1-7
Buttons	1-8
Softkeys	1-8
Setups	1-9
The Setup Menus	1-9
Setup Summary Tables	1-11
Setup Change Procedure	1-15
Example Setup Sequences	1-18
Setup Definitions	1-19
Test Setup Menu	1-19
Format Setup Menu	1-25
System Setup Menu	1-30
I/O-Doc Setup Menu	1-34

Section 2. Testing a Fiber

Testing a Fiber	2-1
Fiber Test Procedure	2-3
The Waveform Defined	2-8

The Event Table Defined	2-11
Fiber Notes	2-13
Using The Cursors	2-15
Using the SELECT Button and Arrow Keys	2-17
SELECT Button Options	2-17
Zoom the Waveform to Magnify an Event	2-19
Zoom Procedure	2-20
Real-Time and High-Density Testing	2-21
Test Procedure	2-21
Adding and Deleting User-Placed Events	2-23
Add/Delete User-Placed Event Procedure	2-23
Adding Notes to Events	2-26
Procedure to Add Notes to an Event	2-27
File Storage	2-29
Introduction	2-29
Floppy Disk Formatting	2-30
File Storage Procedure	2-31
Save	2-31
Load	2-36
Copy	2-38
Delete	2-40
Printing Files	2-43
Print Procedure	2-45
Copying Files to a Personal Computer	2-49
Copy Procedure	2-51

Section 3. Battery Recharging and Replacement

Recharging the NiCad Battery	3-1
Low-Battery Warning	3-1
When to Recharge the NiCad Battery	3-1
Power/Charger Adapter	3-2
NiCad Battery Recharging Procedure	3-3
Tips for Maximizing Battery Life	3-4
NiCad Battery Removal and Replacement	3-5

Section 4. Maintenance

Cleaning	4-1
Cleaning Materials	4-1
Exposing the Laser Output Port for Cleaning	4-2
Cleaning the Laser Output port	4-3
Cleaning the Connector Adapter	4-4

Cleaning the Fiber Connector	4-5
Troubleshooting	4-7
TFS3031 Does Not Power On	4-7
Error Message Resolution	4-8
Front Panel Connection Status	4-8
Self Test Error Message	4-8
Fatal Error Code	4-9

Section 5. Specifications, Accessories, and Options

Specifications	5-1
Accessories and Options	5-7
Keyboard Definitions	5-13

Index

Table of Contents

General Safety Summary



CAUTION. Refer all repair problems to qualified service personnel. Page xiii has a list of phone numbers to call for service information.

Injury Precautions

Review the following safety precautions to avoid injury and prevent damage to this product or any products connected to it.



WARNING. INVISIBLE LASER RADIATION. To eliminate hazardous laser radiation exposure, do not use controls or adjustments, or perform procedures other than those specified in this manual.

Laser Radiation. The TFS3031 tests optical fibers by emitting short pulses of laser light. The interval between pulses is large compared to the pulsewidth. Although the pulsed power is in the milliwatt range, the average power is only in the microwatt range. The light is emitted through the Laser Output port on the right side-panel, and is invisible to the human eye.

The TFS3031 is classified as a CFR Class I and IEC Class 1 laser product under the Radiation Control and Health Safety Act of 1968, and complies with 21 CFR 1040.10 and 1040.11.

Even though the TFS3031 is categorized as a Class I, 1 laser product (the lowest classification), you should avoid exposing your eyes to its light:

- Do not look into the Laser Output port when the TFS3031 is turned on.
- Keep the dust cap on the Laser Output port when not in use.
- Avoid looking at the free end of a test fiber (the end not connected to the TFS3031). If possible, direct the free end toward a non-reflective surface.

Beam Properties.

Beam Divergence (Degrees)

Option	850 nm	1300 nm	1310 nm	1550 nm
01	16	—	—	—
03	16	16	—	—
04	—	—	5.7	—
06	—	—	5.7	5.6
08	—	—	5.7	5.6
09	—	—	—	5.6

Maximum pulse duration of 20 μ s for options 04, 06, 08, and 09; 0.1 μ s for 850 nm; 1.0 μ s for 1300 nm. Maximum duty factor of 1% for all options.

Maximum Laser Peak Power Output

Option	850 nm	1300 nm	1310 nm	1550 nm
01	3 W	—	—	—
03	3 W	0.3 W	—	—
04	—	—	25 mW	—
06	—	—	25 mW	15 mW
08	—	—	70 mW	60 mW
09	—	—	—	110 mW

Uncertainty in maximum output power values $\pm 10\%$. Aging does not increase laser peak power.

Optical Output. When a fiber is *not* connected to the Laser Output port, the TFS3031 may emit laser light briefly in the following circumstances:

- In IntelliTrace mode, during the connection status portion of the test until the user either terminates the test or allows it to continue under the “connection status” warning.
- During any non-automatic test until averaging is complete.
- During a real-time test until terminated by the user.

Power Sources. The TFS3031 is designed to operate from an internal, rechargeable, 12 cell, 14.4 volt nickel-cadmium (NiCad) battery, or a power/charger adapter rated at 9 to 16 volts DC, 40 watts.

Battery. Do not expose the battery to fire or intense heat. Do not open or mutilate the battery. Avoid contact with released electrolyte which is corrosive and may damage eyes, skin, and clothing. Check with local codes for special disposal instructions. Only the entire battery is replaceable. Individual cells are not replaceable.

External Power. Use only the power/charger adapter that is specified for the TFS3031.



CAUTION. *The power/charger adapter is not hermetically sealed. Do not expose it to moisture.*

Fuse. The TFS3031 contains a 3.5 amp, 125 volt, fast-acting fuse on the Power Supply board. The fuse is not user-replaceable.

Do Not Operate in Explosive Atmospheres. Do not operate the TFS3031 in an explosive atmosphere unless it has been certified for that kind of operation.

Do Not Remove Covers or Panels. Do not remove TFS3031 covers or panels (except to access the battery), nor operate the instrument without covers and panels in place.

Electromagnetic Emissions. The TFS3031 has been verified for compliance to FCC Class A and European Union EMC without optional accessories HC411 03 and HC411 03 A1.

Safety Terms and Symbols

Terms in This Manual



WARNING. *Warning statements identify conditions or practices that could result in injury or loss of life.*



CAUTION. *Caution statements identify conditions or practices that could result in damage to this product or other property.*

Terms on the Product

DANGER indicates an injury hazard immediately accessible as you read the marking.

WARNING indicates an injury hazard not immediately accessible as you read the marking.

CAUTION indicates a hazard to property including the product.

Symbols on the Product



DANGER
High Voltage



Protective Ground
(Earth) Terminal



ATTENTION
Refer to
Manual



Preface

If You Need Help

User, service, and application information for the TFS3031 are available by calling one of these Tektronix phone numbers:

☎ **800-TEK-WIDE (835-9433)** toll free in USA and Canada.

☎ **503-627-7111** toll call from anywhere in the world.

☎ **503-690-3926** FAX from anywhere in the world.

For immediate on-screen help when operating the TFS3031, push the **HELP** button on the front panel.

The address of the Tektronix product group that manufactured the TFS3031 is:

Tektronix, Inc.
P.O. Box 1197
625 S.E. Salmon Street
Redmond, Oregon 97756-0227 U.S.A.

Before Operating

To prevent injury to yourself or damage to equipment:

- Read the “General Safety Summary” at the beginning of this manual.
- Heed all warnings, cautions, and notes in this manual.

Assumptions

The procedures in this manual assume that you have a working knowledge of fiber-optic cable test procedures and terminology, and that you are a qualified operator of fiber-optic cable test equipment.

How to Use this Manual

NOTE. *The procedures in this manual apply to all instrument options, both singlemode and multimode.*

This manual is arranged so that you can use the TFS3031 to successfully test a fiber after reviewing sections 1 and 2 only.

- **Section 1. Getting Started.** Locations and descriptions of ports, buttons, and softkeys. Instrument setups.
- **Section 2. Testing a Fiber.** How to: 1) test a fiber and make fiber measurements; 2) store test files in internal memory or floppy disk; 3) print files; and 4) copy files to a personal computer.
- **Section 3. Recharging the NiCad Battery.** How to recharge and replace the NiCad battery, and use the power-charger adapter.
- **Section 4. Maintenance.** Cleaning and troubleshooting information.
- **Section 5. Specifications, Accessories, and Options.** Tables of instrument specifications, accessories, and options. Includes tables of key sequences for the optional keyboard.

In this manual, the words *trace* and *waveform* mean the same, and refer to the analog image of a fiber displayed on the LCD after a test.

Because of different instrument configurations and operating setups, the example screens printed in this manual may not be facsimiles of screens displayed by your instrument.

Service and Warranty

Tektronix warrants the TFS3031 for one (1) year from date of purchase. A warranty statement is printed in front of this manual.

Tektronix provides warranty and post-warranty repair service at its manufacturing facility in Redmond, Oregon U.S.A., and at most Tektronix service locations worldwide.

For service and warranty information refer to the list of phone numbers on page xiii.

Port Functions

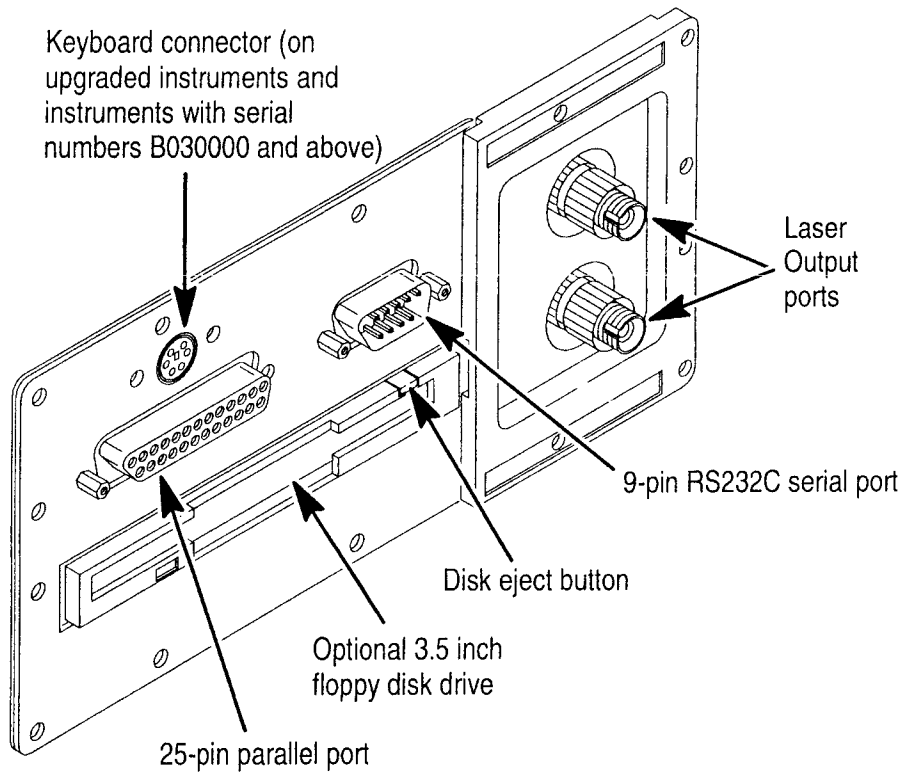

Dust caps and labeling omitted from illustration

Laser Output Port and Connector Adapter

Laser Output Port

The test fiber connects to the Laser Output port located on the side panel. Light is emitted from the Laser Output port into the test fiber.

If both singlemode and multimode Laser Output ports are installed, the singlemode port is in top position and multimode port in bottom position. If one Laser Output port is installed, it will always be in the bottom position. The ports are identified by label.



CAUTION. Do not fire the laser (push the **START/STOP** button) unless a fiber is connected to the Laser Output port. Severe damage to internal electronics can result.

Connector Adapter

The connector adapter attaches the fiber to the Laser Output port. Connector adapters are packaged separately with new instruments, and must be installed on the Laser Output port before use.

The connector adapter on the TFS3031 must match the connector on the test fiber. See page 5–9 for a list of connector adapter options.

Connector Adapter Installation and Removal

Connector adapters are keyed for proper mating with the Laser Output port.

To install a connector adapter, align the keyed elements, slide the connector adapter onto the Laser Output port, and turn *clockwise* until the connector adapter is finger tight (see Figure 1–1).

To remove a connector adapter, unscrew it *counterclockwise* and pull it straight off the port.

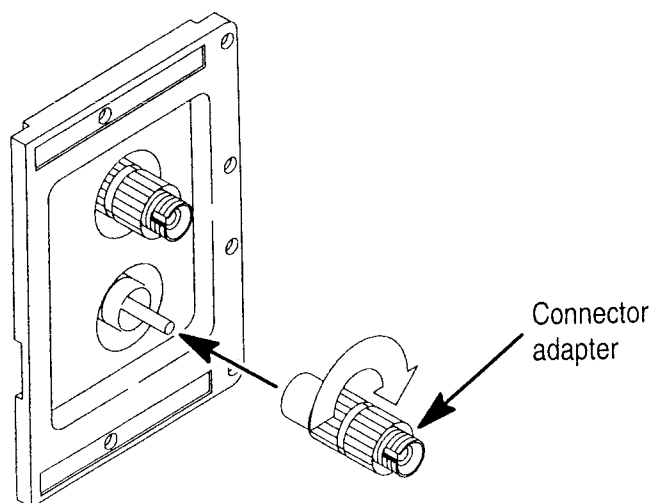

Figure 1–1: Connector Adapter Installation



CAUTION. *Do not touch the exposed end of the Laser Output port with anything but the proper cleaning materials. See page 4-1 for cleaning instructions.*

To protect against damage, all ports should be covered with their dust caps when not in use.

RS232C Serial Port

The 9-pin RS232C serial port connects to an external serial-type printer or computer. See pages 2-43 and 2-49, and Table 5-4 on page 5-3, for information about using the serial port.

Parallel Port

The 25-pin parallel port connects to an external parallel-type printer. See page 2-43 for information about using the parallel port.

Keyboard Connector

A mini-DIN connector is available for an optional keyboard (on upgraded instruments, and instruments with serial numbers B030000 and above). Refer to section 5 for tables of keyboard sequences that duplicate front-panel controls and functions.

Floppy Disk Drive

The 1.44 Mbyte, 3.5 inch floppy disk drive for storage of test files is an optional accessory installed as Option 11. See page 2-29 for file storage information.

The floppy disk should be removed from the disk drive when not in use.

Formatting a Floppy Disk

Both new and used floppy disks may have to be formatted. Formatting destroys any data already on a disk.

To format a disk:

1. Insert an unformatted disk in the floppy disk drive.
2. Push the **Store** or **Print** softkey to access file storage. The TFS3031 checks the drive for a disk and determines if the disk can be read. An unformatted disk cannot be read.

If the drive contains an unformatted disk, you are prompted to format by pushing the **Yes** softkey, or not to format by pushing the **No** softkey.

3. To format the disk, push the **Yes** softkey.

A final yes/no confirmation prompt is displayed along with a notice that formatting the disk will destroy any data already on it.

4. Push the **Yes** softkey again to confirm formatting.

*If you insert an unformatted disk while already in file storage, steps 2, 3, and 4 are displayed when you use the **Save**, **Load**, **Copy**, **Delete**, or **Print** file options that involve accessing the floppy disk (when toggling the **Internal/Floppy** softkey).*

Power/Charger Adapter Port

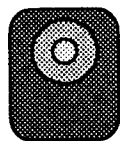

The power/charger adapter port (2.5 mm DIN), located on top of the TFS3031, connects to the power/charger adapter and optional cigarette lighter adapter cable.

The power/charger adapter recharges the NiCad battery and powers the instrument independent of the battery.

The battery must be charged before first use, and recharged when the low-battery warning message is displayed on the screen. See page 3-2 for battery recharging instructions.



CAUTION. *Do not connect the power/charger adapter or cigarette lighter adapter cable to the TFS3031 when the ambient temperature exceeds 40⁰ C (104⁰ F).*

Buttons and Softkeys

Battery indicator. See page 3-1 for battery and power information.

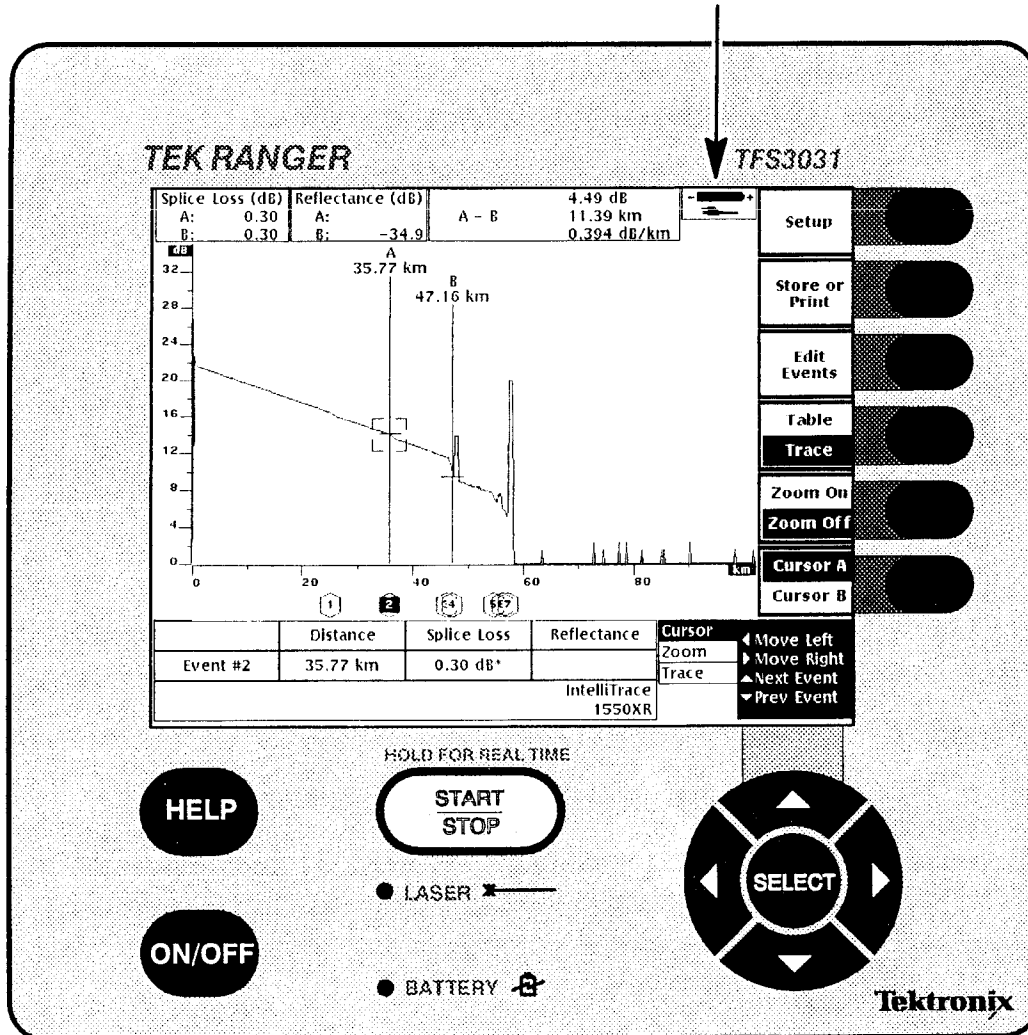

SELECT Button and Arrow Keys

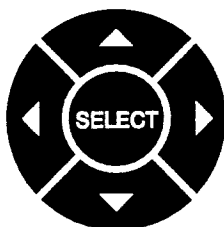

Use the SELECT button and arrow keys to move the cursors, manipulate the waveform, edit events in the waveform/table display, and select and change instrument setups.

Buttons



The ON/OFF button powers the TFS3031 on and off.



The HELP button provides on-screen descriptive information about the current instrument function or status.

For information about a button or softkey, push the HELP button, then push the button or softkey in question.

Push the HELP button again to exit help.



The START/STOP button starts a test and stops a test in progress. In Manual mode, hold down the START/STOP button for at least two seconds to begin real-time testing.

Softkeys

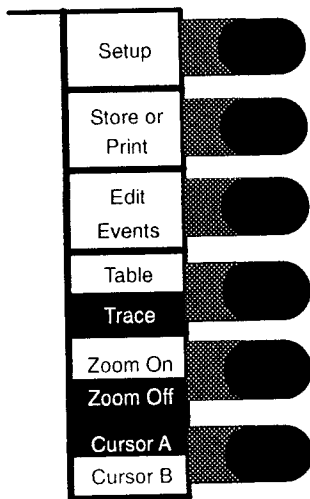

Softkeys control the operation of the TFS3031.

Softkeys are displayed along the right side of the screen next to their pushbuttons. Softkey functions vary according to the current operating status of the instrument.

Some softkeys toggle between dual functions, such as the Cursor A/Cursor B softkey. In dual-function cases, the currently active function is indicated by highlighted text. In this illustration, the Trace, Zoom Off, and Cursor A softkeys are highlighted and are therefore active.



Setups

Instrument setups establish the operating parameters of the TFS3031.

Always check and verify setups before testing a fiber. Incorrect setups can result in inaccurate test results.

The Setup Menus

To access the setup menus, push the **Setup** softkey.

The setup menus are:

- **Test Setup.** Configures the TFS3031 to the specifications of the fiber under test.
- **Format Setup.** Selects the type and amount of test data to be displayed on the screen.
- **System Setup.** Sets the internal time and date clocks, and backlight time-out. Adjusts display contrast. Selects instrument language. Establishes power-on default setups.
- **I/O–Doc Setup.** Establishes external port, printer, and file setups. Defines your company name that will be displayed on the power-on screen and printouts.

Setup menu selections are displayed in the bottom right corner of the screen (see Figure 1–2 on page 1–10).

Select each setup menu by pushing the **SELECT** button. Access and change individual setups by pushing the arrow keys. Setups are in effect when they are highlighted on the screen.

To exit setups and resume testing, push the **START/STOP** button. Or push the **Exit** softkey first then the **START/STOP** button.

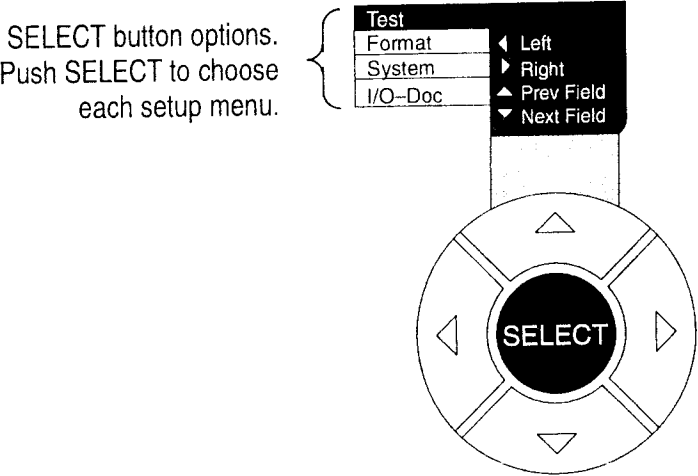

Figure 1-2: Setup Menu Options

Setup Summary Tables

Instructions on how to change setups begin on page 1–15.

Setup descriptions begin on page 1–19.

Table 1–1: Test Setup Menu

Setup	Parameters	Factory Default
Fiber Scan (Test Mode)	IntelliTrace Manual End of fiber	IntelliTrace
Test Range	<i>Wavelength dependent</i>	<i>Fiber Scan dependent</i>
Pulsewidth	<i>Wavelength dependent</i>	<i>Fiber Scan dependent</i>
Averages	256 to 4,194,304	<i>Fiber Scan dependent</i>
Splice Threshold	SM:0.02 to 5.00 dB MM: 0.1 to 5.00 dB 0.01 dB steps	SM: 0.05 dB MM: 0.1 dB
Reflectance Threshold	–60.0 dB to –20.0 dB in 5.0 dB steps	–40.0 dB
Scan For	All Events, Events Above Threshold	Events Above Threshold
End of Fiber Threshold	3 dB to 10 dB in 1 dB steps	3 dB
Refractive Index	1.4000 to 1.6000	1.4680: 1310 SM 1.4685: 1550 SM 1.4776: 850 MM 1.4719: 1300 MM
Distance Units	Meters Feet Miles	Meters
Test Port (Dual-Port Instrument)	Lower Upper	Lower

Table 1–2: Format Setup Menu

Setup	Parameters	Factory Default
Trace Display		
Event	Event measurement data at bottom screen On, Off	On
Cursor A–B	Cursor A to B measurement data at top screen On, Off	On
Splice Loss (at Cursor A and B)	Splice Loss data at top screen On, Off	Off
Reflectance (at Cursor A and B)	Reflectance data at top screen On, Off	Off
Table Display		
Distance	Columns 1 – 10, Off	Column 1
Loss	Columns 1 – 10, Off	Column 2
Reflectance	Columns 1 – 10, Off	Column 3
Slope	Columns 1 – 10, Off	Column 4
Dead Zone	Columns 1 – 10, Off	Column 5
Cumulative Loss	Columns 1 – 10, Off	Column 6
Loss Tolerance	Columns 1 – 10, Off	Column 7
Loss Delta (Between Events)	Columns 1 – 10, Off	Column 8
Distance Tolerance	Columns 1 – 10, Off	Column 9
Distance Delta (Between Events)	Columns 1 – 10, Off	Column 10

Table 1–3: System Setup Menu

Setup	Parameters	Factory Default
System Setup		
Backlight Time	Off, 5 minutes to 4 hours in 5-minute steps, Always On	15 minutes
Contrast Adjust	0 (light) to 255 (dark) in steps of 1	128
Sound	On, Off	On
Power Off Time	Off, 15 minutes to 8 hours in 15-minute steps	30 minutes
Time	0:00:00 to 23:59:59	Current time
Date	1/1/1970 to 12/31/2069	Current date
Date Format	Month/Day/Year Day/Month/Year	Month/Day/Year
Language (Foreign Language Instruments)	English, Spanish, Portuguese, French, Standard Chinese, PRC Chinese, Japanese, German, Italian, Finnish	English
Keyboard Translation	USA, French, German, Spanish, Portuguese, Italian, Finnish	USA
Setups at Power On		
Power-On Defaults	User Setup Last Used Factory	Factory

Table 1-4: I/O-Doc Setup Menu

Setup	Parameters	Factory Default
RS232C Serial Setup		
Baud Rate	1200, 2400, 4800, 9600, 19200, 38400 bps	19200 bps
Flow Control	None XON/XOFF RTS/CTS DTR	None
Printer Setup		
Printer	Epson Seiko DPU411 HP DeskJet HP LaserJet HP ThinkJet PostScript	Seiko DPU411
External Port	Serial Parallel	Parallel
Print Content	Trace Table Trace and Table Setups Fiber Notes	Trace and Table
Company Name	Up to 24 characters	None
File Setup		
File Content	Trace Table Trace and Table Setups Fiber Notes	Trace and Table
File Format	Tektronix Text	Tektronix
Auto Increment	None Name Extension Both	Name

Setup Change Procedure

The following exercise shows you how to change setups. The process is easy: use a combination of the **SELECT** button and arrow keys.

Setups may be viewed or changed during a test in progress. If the Fiber Scan, Test Range, Pulsewidth, or Averages setup is changed during a test in progress, it becomes effective when the *next* test is started (push the **START/STOP** button again). All other setup changes become effective immediately and influence the current test in progress.

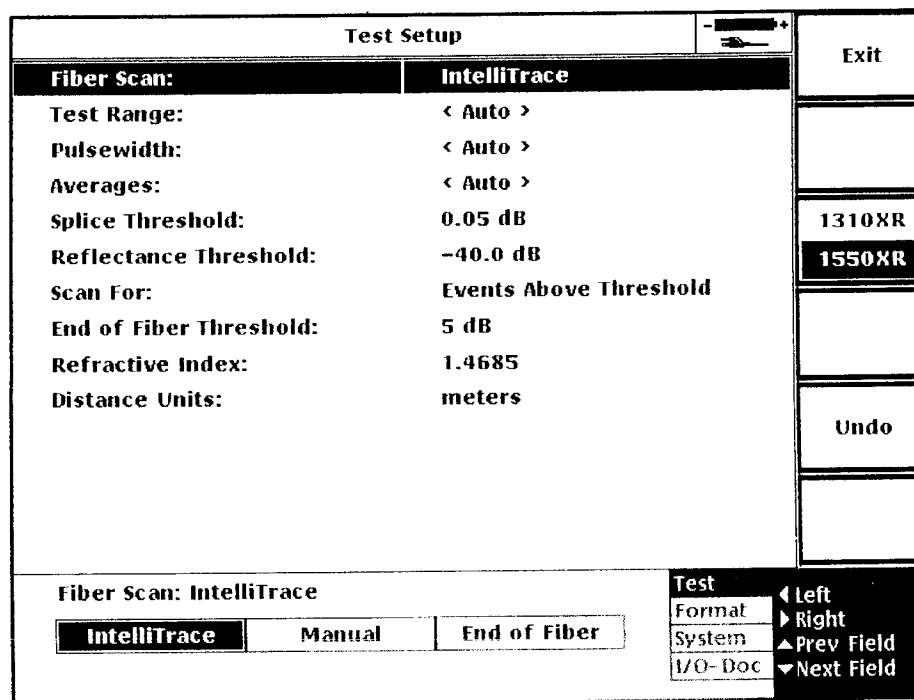

Figure 1–3: Typical Setup Screen.

Step 1. To access the setup menus, push the **Setup** softkey whether or not there is a test in progress.

A setup menu screen similar to Figure 1–3 is displayed. A typical setup screen consists of:

- A *setup field* in mid screen that lists all the setups in a menu. The currently selected setup is highlighted.

- A *change bar* at bottom screen showing the currently selected setup parameter and options. An arrow that indicates more options may show on either end of the change bar.

NOTE. *The setup screen last exited is the same one entered when you push the Setup softkey.*

Step 2. Push the **SELECT** button repeatedly to cycle through the setup menus (Test, Format, System, I/O–Doc). **SELECT** button options are displayed in the lower right corner of the screen.

Choose the *Test Setup* menu to continue with this example.

Step 3. To cycle through the Test setups, push the ▼ or ▲ arrow key repeatedly (or hold the key down).

Notice how the setups cycle in the setup field and change bar.

Choose the *Fiber Scan* setup to continue. Fiber Scan sets the test mode of the instrument.

NOTE. *In the Test Setup menu, setups enclosed in angle brackets (< >) are adjusted automatically during the test by the TFS3031 in order to achieve the best results. These setups are not user selectable.*

Step 4. To cycle through the Fiber Scan parameters, push the ► or ◀ arrow key.

Notice how the parameters cycle in the setup field and change bar.

Choose the *Fiber Scan: IntelliTrace* parameter to continue. IntelliTrace is the most commonly used test mode, and is used throughout this manual for the various exercises.

Step 5. Continue to use the arrow keys as described in steps 3 and 4 to change other setups in the Test Setup menu as needed for your application.

NOTE. *If two Laser Output ports are installed in the instrument, make sure that the proper port is selected in the Test Port setup.*

*If you make a mistake in any menu, use the arrow keys to reselect and correct your mistake, or push the **Undo** softkey before going to the next setup.*

Step 6. Push the **SELECT** button to choose the other setup menus (Format, System, and I/O–Doc).

Use the arrow keys as described in steps 3 and 4 to change setups in these menus as needed for your application.

Step 7. When you are through changing setups:

Push the **START/STOP** button to immediately begin a test using your new setups (or first push the **Exit** softkey, then the **START/STOP** button).

–or–

Before exiting setups, save your new setups as the next power-on defaults:

1. Push the **SELECT** button to choose the *System* menu.
2. Push the ▼ arrow key to choose *Power-On Defaults*.
3. Push the ◀ arrow key to select *Last Used*.

See page 1–33 for information about other default options. Only setups established as defaults continue in effect after power off, and battery discharge or removal.

Example Setup Sequences

The following example shows a typical sequence of buttons and keys used to (1) view the setup menus; and (2) change a setup and establish it as a default (the setup is *Splice Threshold* in the *Test* menu).

(1) To view the setup menus:

- push Setup softkey
- push SELECT button (choose *Format* menu)
- push SELECT button (choose *System* menu)
- push SELECT button (choose *I/O-Doc* menu)
- push SELECT button (choose *Test* menu)
- push Exit softkey

(2) To change a setup and establish it as the default:

- push Setup softkey
- push SELECT button (choose *Test* menu)
- push ▼ key (choose *Splice Threshold* setup)
- push ► key (choose *0.50 dB* parameter)
- push SELECT button (choose *System* menu)
- push ▼ key (choose *Power-On Defaults* setup)
- push ◀ key (choose *Last Used*)
- push Exit softkey

Setup Definitions

Test Setup Menu

The Test Setup menu configures the TFS3031 to the specifications of the fiber under test.

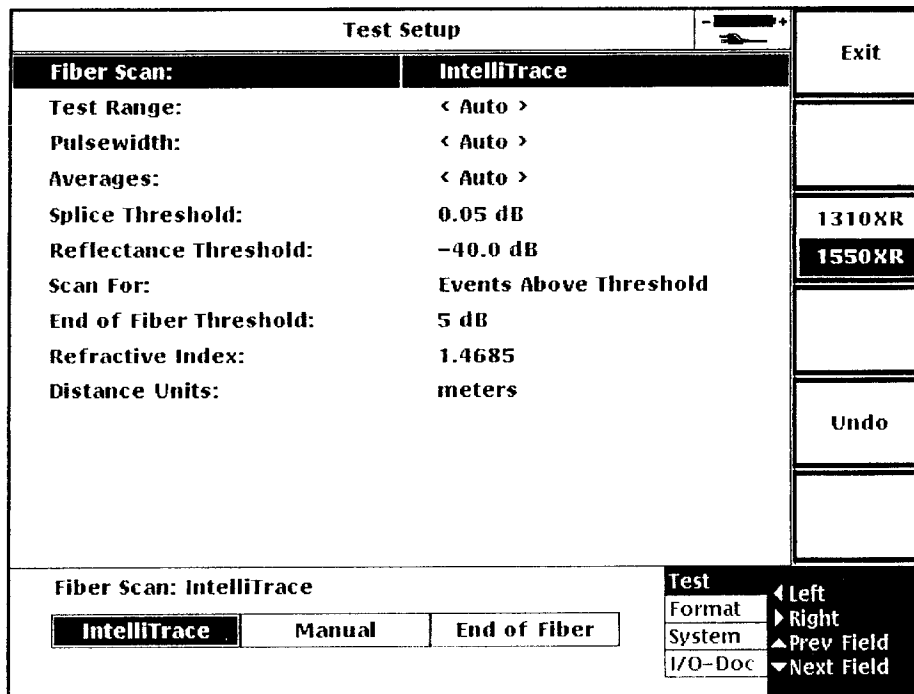

Figure 1-4: Typical Test Setup Menu Screen.

Fiber Scan

The Fiber scan setup specifies the test mode of the instrument. Fiber Scan selections are: IntelliTrace Manual, and End of Fiber.

- IntelliTrace.** IntelliTrace mode automatically locates and measures all events on a fiber. It is the easiest and most commonly used test mode, and is the factory default.

IntelliTrace is a single-button test that automatically adjusts the test setups to provide the best possible resolution for measuring close-in events, while maintaining the necessary dynamic range

for measuring distant events. The result is a more accurate waveform, and an event table that contains more accurate measurements.

IntelliTrace mode automatically adjusts the Test Range, Pulsewidth, and Averages parameters during the test. All other parameters are user settable.

- **Manual.** Use Manual mode when testing with specific Test Range, Pulsewidth, and Averages parameters, and when doing real-time and high-density testing.

The Splice Threshold, Reflectance Threshold, Scan For, and End of Fiber Threshold setups are disabled. All other parameters are user settable.

- **End of Fiber.** End of Fiber mode quickly locates the end of the fiber, and measures total length, slope, and loss. It does not locate or measure other events.

The Test Range, Pulsewidth, and Averages parameters are adjusted automatically. The Splice Threshold, Reflectance Threshold, and Scan For setups are disabled. All other parameters are user settable.

Test Range

Test Range specifies the maximum fiber distance over which test data is acquired. To avoid ghosting, the test range should be set to a little longer than the full length of the fiber.

Test Range depends upon laser wavelength selected. When switching between laser wavelengths (on dual-wavelength instruments), the Test Range parameter automatically changes to accommodate the laser currently selected.

Test Range and Pulsewidth setups are interdependent. Pulsewidth parameters are displayed with the Test Range parameters. If you change the test range, and the current pulsewidth is incompatible, the closest compatible pulsewidth is automatically selected.

Test Range selections depend on the wavelength. Factory default depends on the Fiber Scan setup and the wavelength selected.

Factory default is Auto in IntelliTrace and End of Fiber modes. In Manual mode, factory default is 4 km for 850 nm multimode, 8 km for 1300 nm multimode, and 20 km for all other wavelengths.

Pulsewidth

Pulsewidth specifies the length of time the laser is on during each sampling acquisition, measured in distance units. A sampling acquisition is the acquisition of one complete set of data points on a waveform.

Short pulsewidths permit more detail but have limited range. Long pulsewidths permit longer range but provide less detail.

Certain pulsewidths are not available on some wavelengths. When switching between laser wavelengths (on multi-wavelength instruments), the Pulsewidth parameter may change.

Pulsewidth and Test Range setups are interdependent. Test Range parameters are displayed with the Pulsewidth parameters. If you change the pulsewidth, and the current test range is incompatible, the closest compatible test range is automatically selected.

Factory default depends on the Fiber Scan setup and the wavelength selected. Factory default is Auto in IntelliTrace and End of Fiber modes. In Manual mode, factory default is 10 m for 850 and 1300 nm multimode, and 20 m for all other wavelengths.

Averages

Averages specifies the number of averages required by a test based upon the currently selected pulsewidth and test range.

Increase averages to reduce noise and increase range. An estimate of the time necessary to take the selected number of averages is displayed on the screen.

Selections are 256 to 4,194,304. Factory default depends on the Fiber Scan setup.

Averages is set automatically in IntelliTrace and End of Fiber modes, and is user settable in Manual mode.

Splice Threshold

Splice Threshold specifies the threshold level (in dB) for detecting splices. Splice events that have a loss plus loss tolerance equal to or greater than threshold are indicated on the screen.

Selections are 0.02 to 5.00 dB (singlemode) or 0.10 to 5.00 dB (multimode), in 0.01 dB steps. Factory defaults are 0.05 dB for singlemode and 0.1 for multimode .

Splice Threshold is user settable in IntelliTrace mode, and is disabled in Manual and End of Fiber modes.

Reflectance Threshold

Reflectance Threshold specifies the threshold level (in dB) for detecting reflective events. Reflections equal to or greater than threshold are indicated on the screen.

Selections are -60.0 dB to -20.0 dB in 5.0 dB steps. Factory default is -40.0 dB.

Reflectance Threshold is user settable in IntelliTrace mode, and is disabled in Manual and End of Fiber modes.

Scan For

Scan For specifies whether to display all events or only events higher than the user-set splice and reflectance threshold levels.

Only those events that are scanned for are displayed on the screen. An asterisk (*) marks the splice loss or reflectance measurements that are above the threshold.

Selections are All Events or Events Above Threshold. Factory default is Events Above Threshold.

Scan For is user settable in IntelliTrace mode, and is disabled in Manual and End of Fiber modes.

End of Fiber Threshold

End of Fiber Threshold specifies the threshold level (in dB) for detecting the end of the fiber. The first event that has a loss equal to

or greater than the threshold level is marked as the end of the fiber, then the test stops.

Selections are 3 dB to 10 dB in 1 dB steps. Factory default is 3 dB.

End of Fiber Threshold is user settable in IntelliTrace and End of Fiber modes, and is disabled in Manual mode.

Refractive Index

Refractive index is the ratio between the speed of light in a vacuum to speed of light in a fiber.

Refractive index varies from fiber to fiber and is an important setup for achieving accurate test results. A change in the refractive index affects the distance scale on the screen and fiber measurements.

The refractive index is usually available from the fiber manufacturer.

Selections are 1.4000 to 1.6000. Factory defaults are 1.4680 for 1310 nm singlemode; 1.4685 for 1550 nm singlemode; 1.4776 for 850 nm multimode; 1.4719 for 1300 nm multimode.

Refractive Index is user settable in all modes.

If the refractive index of a fiber is unknown, you can calibrate the index using a known length of fiber, or a fiber containing a segment of known length, as follows:

1. Test the fiber and display the waveform.
2. Position Cursor A on the first point on the leading edge of the event at the start of the fiber segment. Position Cursor B on the leading edge of the event at the end of the segment.

For precise cursor positioning, zoom the waveform (see page 2–15 for instructions on moving the cursors and page 2–19 for information about zooming).

3. Access the *Refractive Index* setup in the *Test* menu.
4. Use the arrow keys to change the Refractive Index parameter. As the parameter changes, the distance scale readjusts, changing the distance to the cursors. When the A–B distance on the Test Setup menu matches the known length of the fiber segment, the Refractive Index setup is correct.

Distance Units

Distance Units specifies measurements to be displayed on the screen in meters, feet, or miles. Factory default is meters.

Distance is displayed on the horizontal scale under the waveform, numerically at the top of each cursor, and in the event table columns.

Distance Units is user settable in all modes.

Test Port

Test Port specifies which Laser Output port option to use if two ports (upper and lower) are installed.

Selections are Lower or Upper port. Factory default is Lower port.

Test Port is user settable in all modes.

This setup is not displayed if your instrument contains only one port.

Format Setup Menu

The Format Setup menu selects the categories of test data to be included on the waveform and event table screens. It lets you customize the screen for your particular needs.

Format Setup		Exit
TRACE DISPLAY		
Event:	On	
Cursor A-B:	On	
Splice Loss:	On	
Reflectance:	On	
TABLE DISPLAY		
Distance:	1	
Loss:	2	
Reflectance:	3	
Slope:	4	
Dead Zone:	5	
Cumulative Loss:	6	Undo
Loss Tolerance:	7	
Loss Delta between events:	8	
Distance Tolerance:	9	
Distance Delta between events	10	
Splice Loss: On		Test
<input type="checkbox"/> Off	<input checked="" type="checkbox"/> On	Format
		System
		I/O-Doc
		◀ Left
		▶ Right
		▲ Prev Field
		▼ Next Field

Figure 1-5: Format Setup Menu Screen.

TRACE DISPLAY Setups

Trace display setups turn on and off data included on the waveform screen.

Event

In the waveform display, Event turns display of measurement data for the event closest to the currently active cursor on and off. Event data is displayed at bottom screen.

Selections are On or Off. Factory default is On.

Cursor A–B

In the waveform display, Cursor A–B turns display of the difference in measurement data between the cursors on and off. Measurement data includes loss in dB, distance, and loss/distance. Cursor A–B data is displayed at top screen.

Selections are On or Off. Factory default is On.

Splice Loss

In the waveform display, Splice Loss turns display of the splice loss measurement at each cursor on and off. Moving a cursor causes the TFS3031 to recalculate the splice loss at the new cursor location. Cursor A and B splice loss data is displayed at top screen.

Selections are On or Off. Factory default is Off.

Reflectance

In the waveform display, Reflectance turns display of the reflectance measurement at each cursor on and off. Moving a cursor causes the TFS3031 to recalculate the reflectance at the new cursor location (if a reflection exists). Cursor A and B reflectance data is displayed at top screen.

Selections are On or Off. Factory default is Off.

TABLE DISPLAY Setups

Table display setups change the order of (or turn off) the columns of data in the event table. Changing the order of a column causes the remaining column numbers to reorder.

Measurements that are turned off will not appear in the table or printouts. However, they are saved when saving a file in storage so that they can be accessed when the file is loaded back onto the screen.

Distance

Distance is the distance to each event from the TFS3031 front panel.

In the event table display, Distance specifies the position of the Distance data column relative to the other columns in the table, or turns the Distance column off.

Selections are columns 1 through 10; Off. Factory default is column 1.

Loss

Loss is the loss of optical power due to scattering, absorption, and bending.

In the event table display, Loss specifies the position of the Loss data column relative to the other columns in the table, or turns the Loss column off.

Selections are columns 1 through 10; Off. Factory default is column 2.

Reflectance

Reflectance is the ratio of reflected optical power to incident optical power for reflective events.

In the event table display, Reflectance specifies the position of the Reflectance data column relative to the other columns in the table, or turns the Reflectance column off.

Selections are columns 1 through 10; Off. Factory default is column 3.

Slope

Slope is attenuation of the fiber between an event and the preceding event.

In the event table display, Slope specifies the position of the Slope data column relative to the other columns in the table, or turns the Slope column off.

Selections are columns 1 through 10; Off. Factory default is column 4.

Dead Zone

Dead zone is the distance from the beginning of an event to the point at which backscatter is detected, and subsequent events can be accurately detected and measured.

In the event table display, Dead Zone specifies the position of the Dead Zone data column relative to the other columns in the table, or turns the Dead Zone column off.

Selections are columns 1 through 10; Off. Factory default is column 5.

Cumulative Loss

Cumulative loss is the total loss from the TFS3031 front panel to each event.

In the event table display, Cumulative Loss specifies the position of the Cumulative Loss data column relative to the other columns in the table, or turns the Cumulative Loss column off.

Selections are columns 1 through 10; Off. Factory default is column 6.

Loss Tolerance

Loss tolerance is the repeatability of the splice loss at each event.

In the event table display, Loss Tolerance specifies the position of the Loss Tolerance data column relative to the other columns in the table, or turns the Loss Tolerance column off.

Selections are columns 1 through 10; Off. Factory default is column 7.

Loss Delta (Between Events)

Loss delta is the loss between an event and the preceding event.

In the event table display, Loss Delta specifies the position of the Loss Delta data column relative to the other columns in the table, or turns the Loss Delta column off. The data is for events marked by cursor A and cursor B.

Selections are columns 1 through 10; Off. Factory default is column 8.

Distance Tolerance

Distance tolerance is the repeatability of the distance measurement at each event.

In the event table display, Distance Tolerance specifies the position of the Distance Tolerance data column relative to the other columns in the table, or turns the Distance Tolerance column off.

Selections are columns 1 through 10; Off. Factory default is column 9.

Distance Delta (Between Events)

Distance delta is the distance between an event and the preceding event.

In the event table display, Distance Delta specifies the position of the Distance Delta data column relative to the other columns in the table, or turns the Distance Delta column off. The data is for events marked by cursor A and cursor B.

Selections are columns 1 through 10; Off. Factory default is column 10.

System Setup Menu

The System Setup menu:

- Sets the internal time and date clocks.
- Sets backlight timing.
- Adjusts display contrast.
- Selects language.
- Establishes power-on default setups.

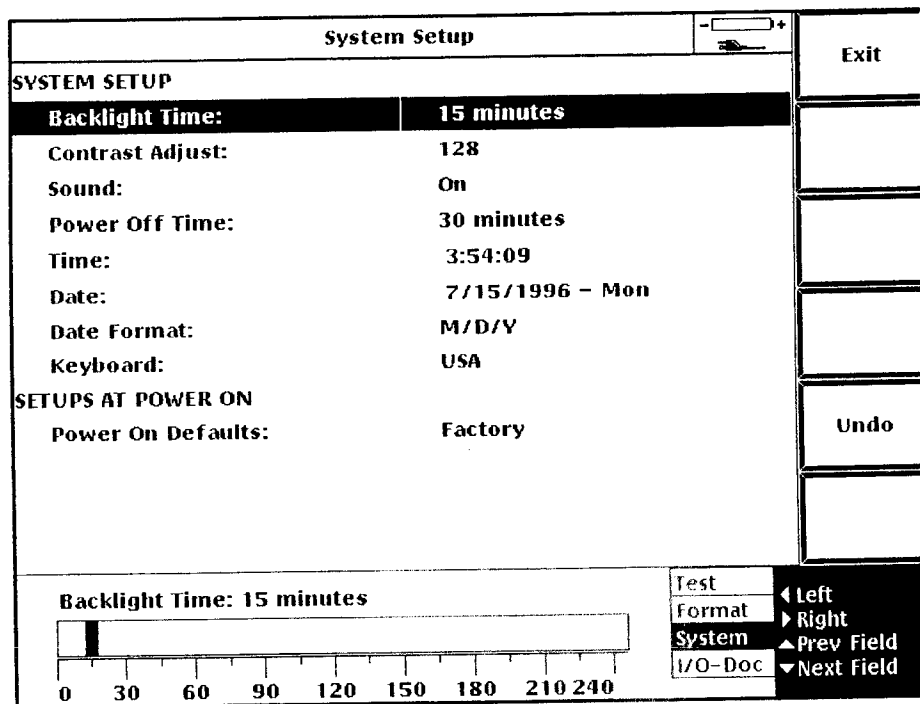

Figure 1-6: System Setup Menu Screen.

SYSTEM SETUP

System setups set and adjust screen contrast, and system date and time features, and instrument language features.

Backlight Time

Backlight Time specifies the amount of time before the backlight blanks to save battery power when button and softkey activity is suspended. The backlight will not blank when the power/charger adapter is plugged in, or when a test is in progress.

Selections are backlight Off, 5 minutes to 4 hours in 5 minute steps, and backlight Always On. Factory default is 15 minutes.

Push any button or softkey to reactivate the backlight after blanking.

Contrast Adjust

Contrast Adjust adjusts the contrast level of the screen for optimum viewing. Selections are 0 (light) to 255 (dark) in steps of 1. Factory default is 128 (average contrast). The TFS3031 always powers up with the same contrast setting that was last used.

To adjust screen contrast, push the ◀ arrow key to decrease contrast, or the ▶ arrow key to increase contrast. Contrast can also be adjusted at initial power on after pushing the ON/OFF button, and before pushing any other buttons or keys.

Sound

Sound provides an audible beep when a test is complete, and when you push an inactive button or softkey.

Selections are On or Off. Factory default is On.

Power Off Time

Power Off Time specifies the amount of time before the TFS3031 powers itself off automatically to save battery power in the event of suspended activity. *The instrument will not time-out when connected to external power, or when a test is in progress.*

Selections are Off (disabled) or 15 minutes to 8 hours in 15 minute steps. Factory default is 30 minutes.

To resume activity after power off, push the ON/OFF button to power the TFS3031 back on.

Time

Time sets the internal time clock to hours:minutes:seconds. Time is used to time-stamp stored, printed, and copied data.

Date

Date sets the internal date clock. The clock is formatted to either month/day/year or day/month/year (depending on Date Format setup). Date is used to date-stamp stored, printed, and copied data.

Date Format

Date Format formats the date display to either month/day/year or day/month/year.

Factory default is month/day/year.

Language

Language establishes the display text language. In addition to English, the TFS3031 may contain any one of the following languages: Spanish, Portuguese, French, standard Chinese, PRC Chinese, German, Japanese, Italian, and Finnish.

Factory default is English.

This setup is displayed only on instruments that have the foreign language options.

When the Power On Defaults parameter is set to Factory, the instrument powers up in the language last used.

Keyboard Translation

Keyboard Translation sets the language used by the keyboard. The selections are USA, French, German, Spanish, Portuguese, Italian, and Finnish. This parameter allows you to set the TFS3031 to recognize a localized keyboard for any of these languages.

If you do not use a localized keyboard when a foreign language is selected for the keyboard translation, the keyboard produces the foreign-language characters regardless of the keycap labels.

Factory default is USA.

When the Power On Defaults parameter is set to Factory, the keyboard powers up in the translation setting last used.

SETUPS AT POWER ON

Power-on setups determine the setups that will be in effect at the next and future power ons.

Power-On Defaults

Power-On Defaults establishes the setups that will be in effect in the future. Default setups remain in effect when the TFS3031 is powered off, and when the battery is discharged or removed.

To establish defaults, first select your setups. Then, before powering off the TFS3031:

1. Push the **SELECT** button to choose the *System* menu.
2. Push the ▼ arrow key to choose the *Power-On Defaults* setup.
 - To save the setups that are in effect when the TFS3031 is powered off as defaults at next power on, push the ◀ arrow key to select *Last Used*.
 - To permanently save your own “personal profile” set of setups for future recall (but not necessarily at next power on), push the ◀ arrow key to select *User Setup*. Then push the **Save Latest User Setup** softkey.

Your personal profile setups are now saved permanently. In the future you can recall your personal profile setups by selecting *User Setup* before powering off the instrument, and they will be the default at next power on.

- To revert to original factory setups as defaults at next power on, push the ◀ arrow key to select *Factory*.

NOTE. For instruments that contain foreign-language options: when the Power On Defaults are set to Factory, the TFS3031 powers up in the language and keyboard translation that were last selected. Note that these setups work the same way for both the Last Used and the Factory settings of the Power On defaults parameter.

I/O–Doc Setup Menu

The I/O–Doc Setup menu establishes RS232C serial, printer, and file setups, and defines your company name to be included with file data.

I/O–Doc Setup		Exit
RS232C SERIAL SETUP		
Baud Rate:	19200	
Flow Control:	None	
PRINTER SETUP		
Printer:	Seiko 411	
External Port:	Parallel	
Print Content:	Trace & Table	
Company Name:		
FILE SETUP		
File Content:	Trace & Table	
File Format:	Tektronix	
Auto Increment:	Name	
Baud Rate: 19200		Test
◀ 4800	9600	▶ Left
19200	38400	▶ Right
		▶ Prev Field
		▶ Next Field

Figure 1–7: Typical I/O–Doc Setup Menu Screen.

RS232 SERIAL SETUP

Serial setups set the baud rate and flow control used when downloading files to a personal computer or printer.

Baud Rate

Baud Rate specifies the RS232C serial port data output rate when copying files to a personal computer or using an RS232 printer.

Selections are 1200, 2400, 4800, 9600, 19200, or 38400 bps. Factory default is 19200 bps.

Flow Control

Flow Control specifies the RS232C serial port data flow control when copying files to a personal computer or using an RS232 printer. If connected to a computer, Flow Control *cannot* be set to XON/XOFF.

Selections are None, XON/XOFF, RTS/CTS, or DTR. Factory default is None.

PRINTER SETUP

Printer setups are setups that affect an external printer.

Printer

Printer specifies the type of external printer used to print files.

Selections are Seiko DPU411, Epson, HP DeskJet, HP LaserJet, HP ThinkJet, and PostScript. Factory default is Seiko DPU411.

Although printers can be connected to the serial port, we recommend using the parallel port. If using the serial port, see Table 5–4 on page 5–3 for information about serial cables and printer setups.

External Port

External Port specifies the communications port (located on the side panel) that connects the TFS3031 to the printer or personal computer.

If connected to a computer, set External Port to *Serial*.

Selections are Serial or Parallel port. Factory default is Parallel port.

Print Content

Print Content specifies the type of test data to be printed. The selections are:

- **Trace**—prints waveform, instrument setups, fiber notes, and event notes.

- **Table**—prints event table, event notes, fiber notes, and instrument setups.
- **Trace and Table**—prints waveform, instrument setups, fiber notes, event table, and event notes.
- **Setups**—prints instrument setups only.
- **Fiber Notes**—prints fiber notes only.

Factory default is Trace and Table.

Company Name

Company Name includes the name of your company (or other identifying text) as part of the power-on screen and on printouts. Up to 24 characters can be included using the editing procedure accessed by pushing the **Edit Company Name** softkey. Factory default is no name.

FILE SETUP

File setups determine the content, formatting, and incrementation of test files.

File Content

File Content determines the content of the file to be stored in memory. Selections are:

- **Trace**—saves waveform data, instrument setups, and fiber notes.
- **Table**—saves the event table, instrument setups, fiber notes, and event notes.
- **Trace and Table**—saves waveform data, event table, instrument setups, fiber notes, and event notes.
- **Setups**—saves instrument setups and fiber notes.
- **Fiber Notes**—saves fiber notes only.

Factory default is Trace and Table.

File Format

File Format formats file output in either ASCII (Text) or Tektronix common file format.

Use Tektronix common file format:

- For storing waveforms.
- When files will be read by other Tektronix OTDRs.
- When using FMTAP, the Tektronix trace analysis software package.
- When copying files to a personal computer.
- When files will be loaded back onto the screen for viewing.

Use Text format only when transferring waveform or event-table data to a spreadsheet. Waveform and event-table files that have been saved in Text format cannot be loaded back onto the screen.

You can reload a fiber-notes-only file that has been saved using Text format. This allows you to edit fiber notes on a PC or workstation, then reload them into the TFS3031. Fiber notes are formatted in the following format:

title;description

Title is a field up to 23 characters in length. **Description** is a field up to 55 characters in length. The title and description fields are separated by a semicolon. The fiber-notes file can contain up to 15 of these notes.

If you edit file notes in a Text-format file, be sure to edit only the lines of note text. Leave the rest of the file unchanged in order to ensure that it will reload properly on the TFS3031.

Factory default is Tektronix common file format.

Auto Increment

Auto Increment specifies how file names are automatically incremented.

Selections are None (disabled), Name, Extension, or Both (name and extension). Factory default is Name.

Examples:

Name: FILE0001.CFF increments to FILE0002.CFF
FILE_A.CFF increments to FILE_B.CFF

Extension: FILE.001 increments to FILE.002
FILE.AAA increments to FILE.AAB

Both: FILE0018.999 increments to FILE0019.000
FILE00A.ABC increments to FILE00B.ABD

Testing a Fiber

This section provides exercises and examples on how to test a fiber and make fiber measurements. The procedures apply to all instrument options, both singlemode and multimode.

For simplicity, these exercises use *Fiber Scan: IntelliTrace* mode, the most commonly used mode for testing a fiber.

We suggest that you use IntelliTrace mode to become familiar with how the TFS3031 works. Then use the other modes (Manual and End of Fiber) as needed.

Note that when you exit a test in progress to go to another process, the test continues. To start a test over, push the **START/STOP** button.



WARNING. INVISIBLE LASER RADIATION. *To eliminate hazardous radiation exposure do not use controls or adjustments or perform procedures other than those specified in this manual.*

Avoid eye exposure to laser output and open-ended fibers by covering the end or directing the output at a nonreflective surface.



CAUTION. *Do not fire the laser (push the **START/STOP** button) unless a fiber is connected to the Laser Output port. Severe damage to internal electronics can result.*

NOTE. *Before using the TFS3031, recharge the NiCad battery to capacity, and clean the Laser Output port and fiber connectors.*

- *See page 3–2 for NiCad battery recharging instructions.*
 - *See page 4–1 for optical cleaning instructions.*
-

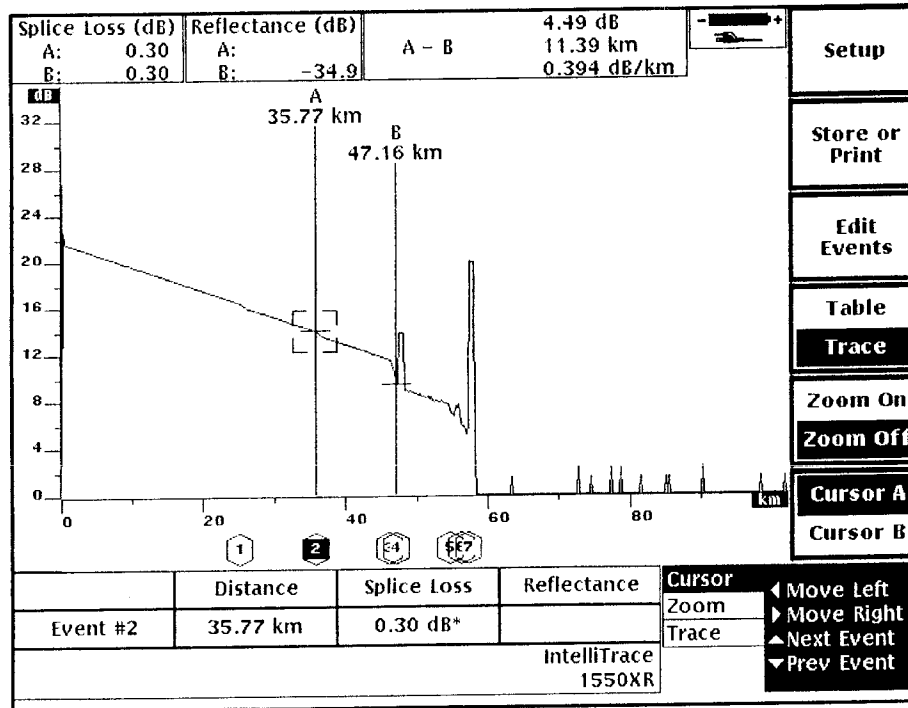

* - Above Threshold				
Event #	Distance (km)	Splice Loss (dB)	Reflectance (dB)	Slope (dB/km)
1	25.075	0.251*	(n/a)	0.202
2	35.769	0.302*	(n/a)	0.202
3	46.140	2.121*	(n/a)	0.202
4	47.164	0.296*	-34.9*	0.202
5	54.731	0.349*	(n/a)	0.202
6	56.236	2.445*	(n/a)	0.202
7	57.167	>-3.577*	-14.0*	0.202

Figure 2-1: Typical IntelliTrace Test Screens: Waveform (Top) and Event Table (Bottom). Seven Events are Detected. Event 2 is Selected.

Fiber Test Procedure

The following example describes how to test and make measurements on a fiber. This example is typical of a new first-time test after instrument power on.

Step 1. Connect the test fiber to the connector adapter on the appropriate Laser Output port (on dual-port instruments).

Connect the fiber directly to the port or use a jumper cable. The connection should be finger tight.

The connector adapter and fiber connector must match. If necessary, see page 1–2 for connector adapter installation instructions.

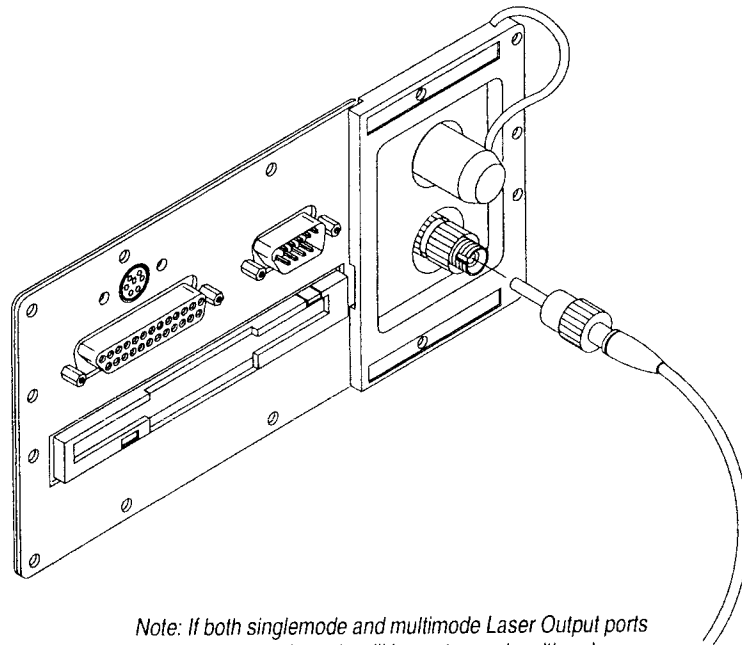

Note: If both singlemode and multimode Laser Output ports are installed, singlemode will be on top and multimode on bottom. If one Laser Output port is installed, it will always be on the bottom whether singlemode or multimode. The ports are identified by label.

Step 2. Push the ON/OFF button to power on the TFS3031.

Wait a moment. The instrument goes through a power-on self test sequence, and displays the following “ready” screen after successful power on.

Note that screen contrast can be adjusted now.

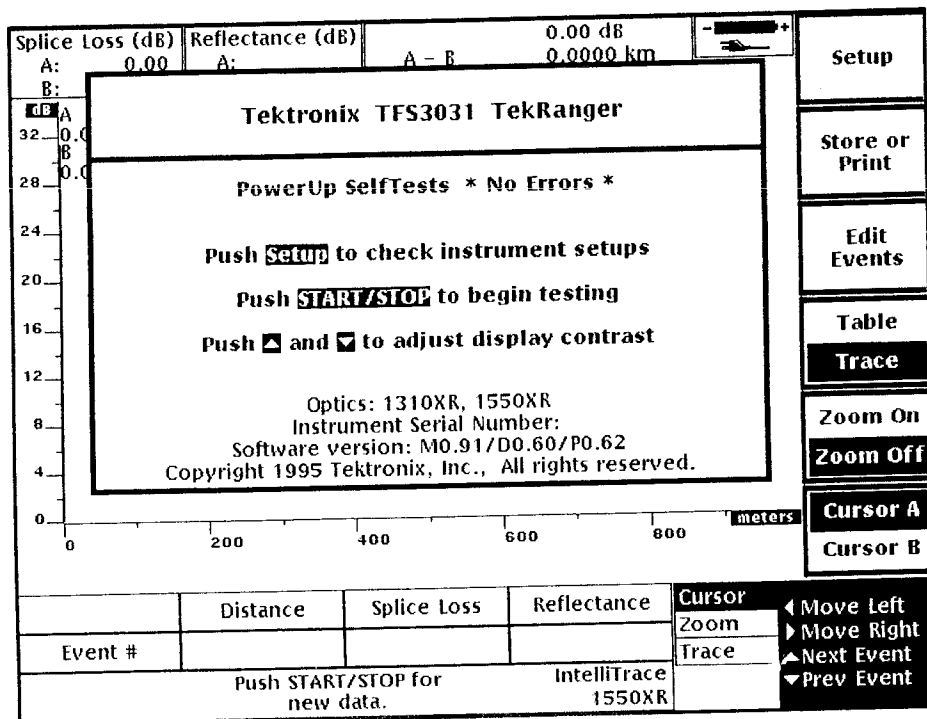

If the TFS3031 displays an error message during power on, see page 4-1 for cleaning and troubleshooting instructions.

Step 3. (OPTIONAL). Check your setups to make sure that the TFS3031 is configured properly for the test.

Push the Setup softkey. Then push the SELECT button to view the setup menus. *If necessary, see page 1-9 for information about reviewing and changing setups.*

- If two Laser Output ports are installed, make sure that the proper port is selected using the *Test Port* setup in the *Test Setup* menu.

1310XR**1550XR**

- If a dual-wavelength port is installed, make sure the proper wavelength is selected as indicated by the “wavelength” softkey (third softkey down on the front panel when the *Test Setup* menu is displayed).
- For the purpose of this exercise, make sure that the *Fiber Scan: IntelliTrace* setup is selected in the *Test Setup* menu. IntelliTrace allows full automatic testing.

Step 4. Push the **START/STOP** button to exit setups and begin testing the fiber.

Wait a moment. The flashing red **LASER LED** on the front panel indicates that the test is in progress. The screen also displays an elapsed time for the test.

*To stop a test in progress anytime, push the **START/STOP** button.*

Step 5. When the test is complete, results are displayed on the screen as either a *waveform* or *event table* (see Figure 2–1 on page 2–2, and the waveform/event table descriptions on pages 2–8 and 2–11).

Push the **Table/Trace** softkey to toggle between the waveform and event table screens. Notice the difference in display formats for the same test.

To continue with this exercise, display the *waveform* screen.

Step 6. Bring both cursors into view on the waveform.



The cursors, labeled A and B, are used for making fiber measurements.

When a waveform is first acquired, the cursors are at the zero distance point on the waveform (left side of the screen). They are hard to see except for their distance indicators that show 0.0 distance.

To bring the cursors into view for making measurements:

1. Push the **SELECT** button to choose the *Cursor* option (as highlighted in lower right screen – see Figure 2–2 on page 2–8). The *Cursor* option enables the arrow keys for cursor movement.

For this exercise, assume that cursor A is the active cursor (Cursor A softkey highlighted).

2. Hold down either the  arrow key to scroll cursor A along the waveform, or the  arrow key to jump cursor A from event to event, until cursor A is positioned on the *first* point on the leading edge of the *first* event to be measured.

To see the most detail in an event, and for the most precise cursor placement, zoom the waveform. See page 2–19 for information about waveform zooming.

3. Push the **Cursor B** softkey to switch the active cursor to cursor B.
4. Repeat step 2 to position cursor B on the *first* point on the leading edge of the *second* event to be measured.

Step 7. You now have a complete fiber test showing a complete set of measurements at both cursor locations.

Again, push the **Table/Trace** softkey to toggle between the waveform and event table screens. Notice the difference between how measurement results are displayed.

Step 8. Continue with the rest of this section to learn more about:

- Contents of the waveform screen (page 2–8).
- Contents of the event table screen (page 2–11).
- Using the cursors (page 2–15).
- Using the **SELECT** button and arrow keys (page 2–17).
- Zooming the waveform (page 2–19).
- Real-time and high-density testing (page 2–21).

- Adding and deleting user-placed events (page 2–23).
- Including notes and comments with events (page 2–26).
- Storing files in memory and editing file names (page 2–29).
- Printing files (page 2–43).
- Copying files to a personal computer (page 2–49).

The Waveform Defined

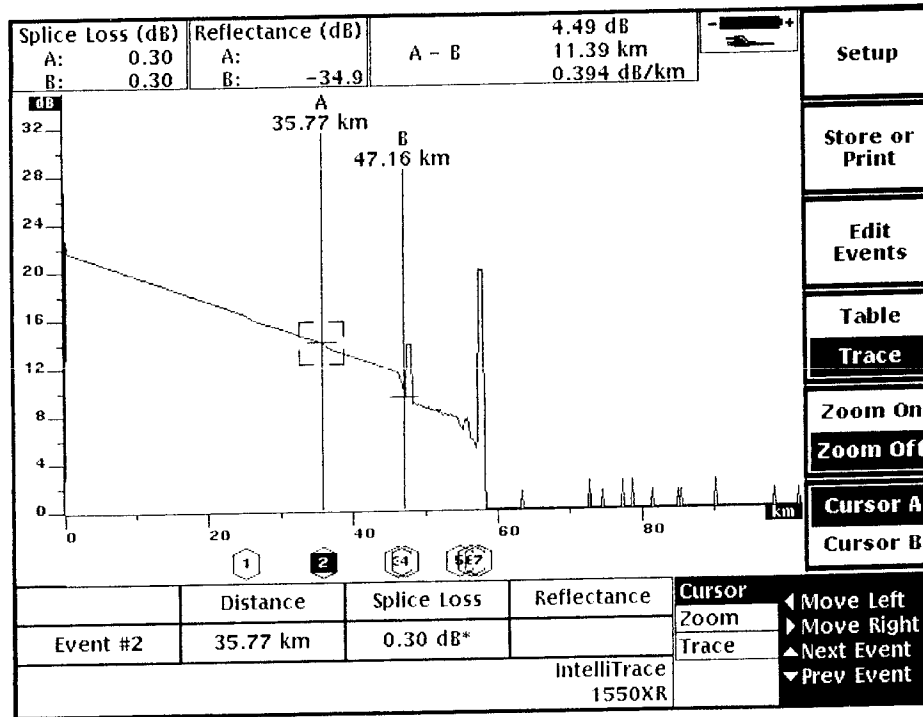



Figure 2–2: Typical Waveform Screen. Event 2 is Selected.

The waveform screen displays an analog representation of the entire tested length of the fiber.

- The scale on the left side of the waveform displays loss in dB units. The scale below the waveform displays distance in meters, feet, or miles.
- Numbered event markers located under the distance scale (④) pinpoint each event detected. The marker for the currently selected event is highlighted. Each event marker corresponds to a numbered event listed in the event table.

In Figure 2–2, seven events are detected. Event number two is currently selected.

- A  symbol located under the distance scale indicates a user-placed event. (There are no user-placed events in Figure 2-2).

See page 2-23 for information about adding user-placed events.

- Information boxes at top and bottom screen display measurement data for events marked by cursors A and B. The boxes at top screen and the Event display at bottom screen can be turned on and off in the Format Setup menu.
- Distance measurements from the front panel to the locations of cursors A and B are displayed at the top of each cursor.
- The **Setup** softkey accesses the setup menus.

See page 1-9 for information about instrument setups.

- The **Store** or **Print** softkey accesses menus for storing, loading, copying, and deleting test files in internal memory and floppy disk; printing files on an external printer; and copying files to a personal computer.

See pages 2-29, 2-43, and 2-49 for information about storing, loading, copying, deleting, and printing test files.

- The **Edit Events** softkey allows adding user-placed events to the waveform, and accesses the **Edit Event Notes** softkey for adding notes to events.

See page 2-23 for information about adding user-placed events.

See page 2-26 for information about adding notes to events.

- The **Table/Trace** softkey toggles between the waveform and event table screens.
- The **Zoom On/Zoom Off** softkey activates waveform zooming for optimum viewing and precise cursor

placement. The zoom window is always centered on the currently active (moveable) cursor.

See page 2–19 for information about zooming the waveform.

- The **Cursor A/Cursor B** softkey toggles between which cursor is active (moveable). Move the active cursor by pushing the arrow keys when the **SELECT** button is in Cursor mode.

In Figure 2–2, cursor A is the currently active cursor.

- **SELECT** button options are: Cursor, Zoom, and Trace.

*See page 2–17 for information about **SELECT** button options.*

The Event Table Defined

* - Above Threshold					Setup
Event #	Distance (km)	Splice Loss (dB)	Reflectance (dB)	Slope (dB/km)	Store or Print
1	25.075	0.251*	(n/a)	0.202	Edit Event Notes
2	35.769	0.302*	(n/a)	0.202	Table
3	46.140	2.121*	(n/a)	0.202	Trace
4	47.164	0.296*	-34.9*	0.202	Exit To Event
5	54.731	0.349*	(n/a)	0.202	
6	56.236	2.445*	(n/a)	0.202	
7	57.167	>-3.577*	-14.0*	0.202	

IntelliTrace 1550XR

Table

◀ Shift Left
▶ Shift Right
▲ Prev Event
▼ Next Event

Figure 2–3: Typical Event Table Screen. Event 2 is Selected.

The event table screen displays results of the test in tabular format starting with the event nearest the front panel located in the Event # 1 position.

- Initially, the event selected by the active cursor is highlighted in the table.
Push the ▼ or ▲ arrow key to scroll up and down to select events.
- The event table holds 10 columns for information about each detected event. Only four of the 10 columns are viewable at any one time in order to keep the screen from being cluttered.

Columns that are not displayed can be viewed by pushing the ◀ or ▶ arrow keys.

The order of the columns can be user-set or turned off in the Format Setup menu.

- The only **SELECT** button option is Table, which enables use of the arrow keys to manipulate the event table.
- The **Edit Event Notes** softkey allows adding notational information to the currently selected event. Notes appear in the Event Notes box at the bottom of the screen.

See page 2–26 for information about adding notes to events.

- The **Table/Trace** softkey toggles between the waveform and event table screens.
- The **Exit To Event** softkey moves the active cursor to the currently selected event and displays the waveform view of the event.
- The Event # column may include the following symbols:
 - A  symbol indicates a user-placed event.
 - The letter **g** indicates that the event is part of a group of events. Grouped events are too close together to be measured separately. The **g** will have a number beside it (**g²**) that designates the group number in which the event occurs.

On grouped events, location and loss are measured, except that loss for the entire group is indicated at the first event in the group.
 - The letter **e** indicates that the event is a possible echo.
 - The letter **m** located on the last event indicates that the event marks the end of the measurement range.
- In the Reflectance and Splice Loss columns, an asterisk (*) indicates that the event is above the user-set threshold value as determined in the Test Setup menu.

Fiber Notes

Store/Print – Save: Edit Fiber Notes			Done
Row	Title	Description	
1	OPERATOR	Bill R.	
2	LOCATION	Downtown 5th & Wall	Edit Field
3	BUNDLE	A-26-F23-S2	Add Row
			Delete Row

Edit Move ◀ Prev Field
 ▶ Next Field
 ▲ Prev Row
 ▼ Next Row

Figure 2–4: Typical Edit Fiber Notes Screen.

Through the file-storage system, you can enter and edit up to fifteen fiber notes associated with the current acquisition. Fiber notes are saved when you save waveform or event-table data, or you can save fiber notes alone into a file. Fiber notes are printed when you print waveform or event-table files.

Enter and edit fiber notes for the current acquisition by pressing the **Store** or **Print** softkey and selecting either the **Save** or the **Print** option.

View fiber notes for files on floppy disk or in internal memory on the **Load**, **Delete**, and **Print** screens.

You can create a fiber-notes file containing template information that can be duplicated for other waveform files, for example, operator and location information. Load this file before or after acquiring test

data, then when you save the waveform data into a file, the template notes can be edited and saved with the waveform.

When you load a fiber-notes file, waveform data for the current acquisition is not affected, but any existing fiber notes are overwritten.

Refer to page 2–33 for information on entering and editing fiber notes for the current acquisition from the Save screen. (These instructions also apply to editing fiber notes from the Print screen.)

Refer to pages 2–37, 2–40, and 2–47 for instructions on viewing stored fiber notes from the Load, Delete, and Print screens.

Using The Cursors

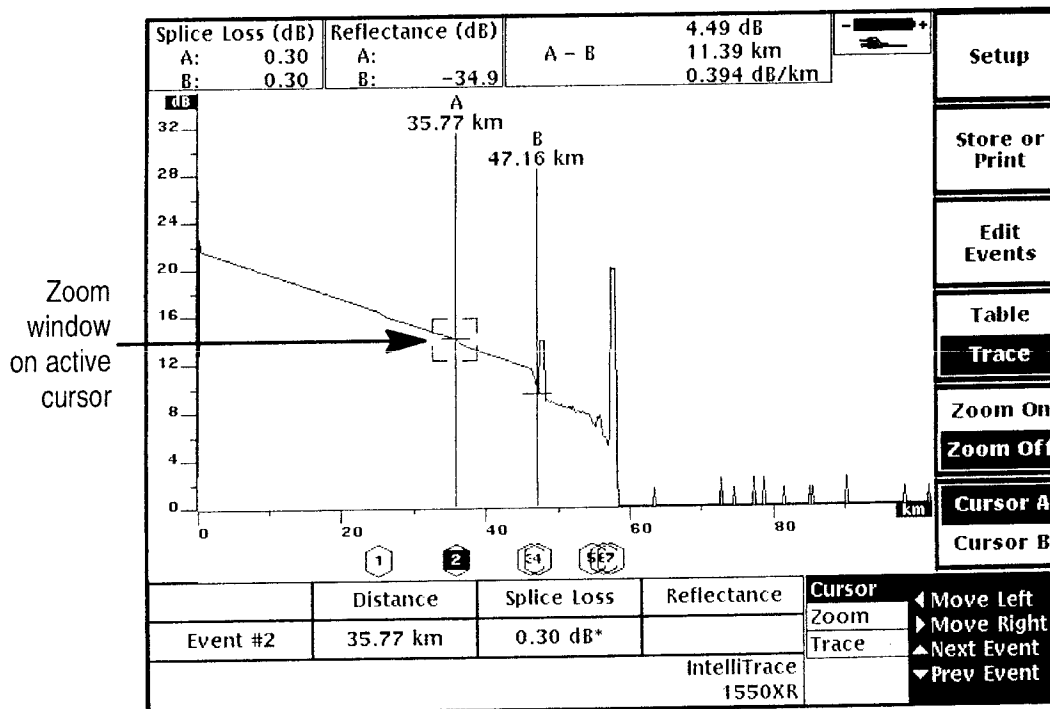

Figure 2-5: Cursors A and B. Cursor A is the Active Cursor.

Use Cursor A and Cursor B to make additional measurements on the waveform. Distance measurements from the front panel to the cursor locations are displayed at the top of each cursor.

The inactive cursor is activated (made moveable) by pushing the **Cursor A/Cursor B** softkey. Move the active cursor by pushing the arrow keys when the **SELECT** button is in *Cursor* mode.

The active cursor is longer than the inactive cursor, and has the zoom window centered on it. The zoom window defines the area of the waveform that magnifies (expands to fill the screen) when the **Zoom On** softkey is pushed. *See page 2-19 for information about zooming the waveform.*

Information boxes at top and bottom screen list measurement data at the location of the cursors. The boxes at top screen and the Event

display at bottom screen can be turned on or off in the Format Setup menu.

To join both cursors at the location of the active cursor, hold down the Cursor A/Cursor B softkey.

Using the SELECT Button and Arrow Keys

SELECT button options are displayed in lower right screen.

Waveform options are *Cursor*, *Zoom*, and *Trace*. The only event table option is *Table*.

After selecting an option, push the arrow keys to execute the various functions.

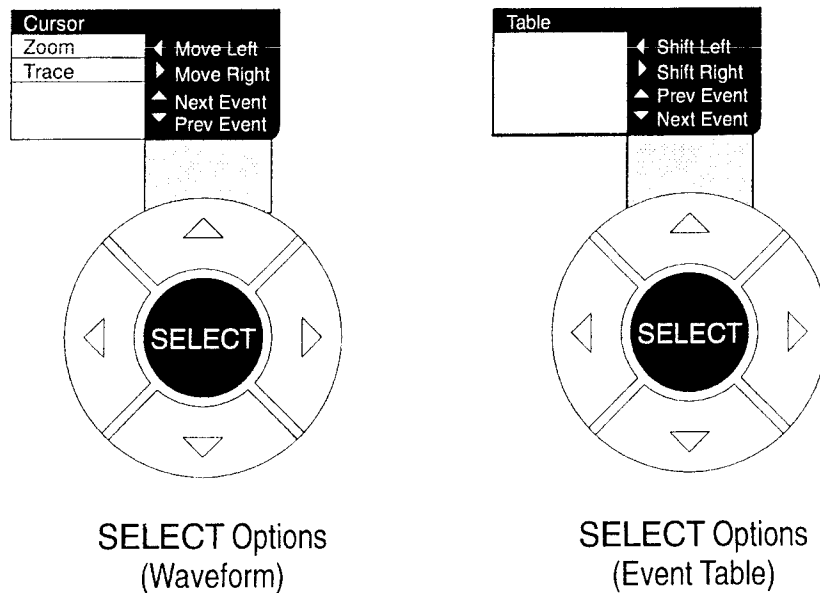

Figure 2-6: SELECT Button Options

SELECT Button Options

Cursor. The Cursor option moves the active cursor along the waveform. When Cursor is selected:

- The ◀ arrow key scrolls the active cursor *left*.
- The ▶ arrow key scrolls the active cursor *right*.
- The ▲ arrow key jumps the active cursor *right* to the next event.
- The ▼ arrow key jumps the active cursor *left* to the previous event.

Zoom. The Zoom option sizes the zoom window for magnification. When Zoom is selected:

- The ◀ arrow key *contracts* the zoom window *horizontally*.
- The ▶ arrow key *expands* the zoom window *horizontally*.
- The ▲ arrow key *expands* the zoom window *vertically*.
- The ▼ arrow key *contracts* the zoom window *vertically*.

Trace. The Trace option shifts the waveform on the screen for optimum viewing. When Trace is selected:

- The ◀ arrow key shifts the waveform *left*.
- The ▶ arrow key shifts the waveform *right*.
- The ▲ arrow key shifts the waveform *upward*.
- The ▼ arrow key shifts the waveform *downward*.

Table. In the event table, the Table option allows selection of events, and shifts the viewing of columns of measurement data.

- The ◀ arrow key shifts the view of the event table *left* to display columns of data that are currently off the left side of the screen.
- The ▶ arrow key shifts the view of the event table *right* to display columns of data that are currently off the right side of the screen.
- The ▲ arrow key selects events *upward* in the table (closer to the front panel).
- The ▼ arrow key selects events *downward* in the table (farther from the front panel).

NOTE. Additional **SELECT** button options let you edit, store, and print files. These options are explained in other parts of this manual.

Zoom the Waveform to Magnify an Event

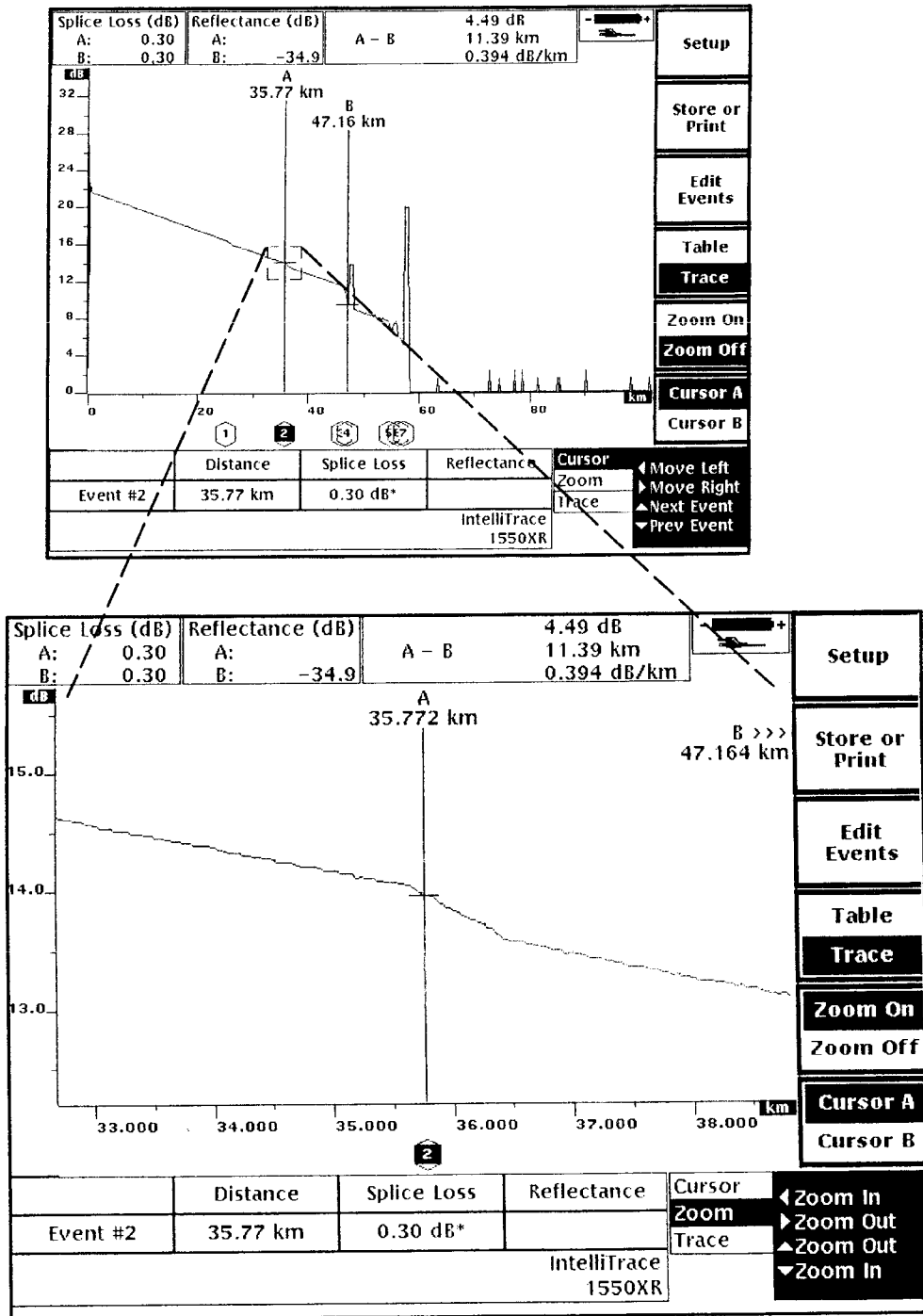





Figure 2-7: Typical Zoomed Waveform Screen. Event 2 is Zoomed.

Waveform zooming lets you see more detail in an event, enables optimum accuracy when positioning a cursor, is useful when testing in real-time mode, and is necessary for high-density testing.

The zoom window is a “box” that is always centered on the *active* cursor. The area within the zoom window expands to fill the entire screen when the Zoom On softkey is pushed.

Zoom Procedure

- Step 1.** On the waveform, position the active cursor on the *first point on the leading edge* of the event in question.
- Step 2.** Push the SELECT button to choose the *Zoom* option.
- Step 3.** Push the  or  arrow key to expand or contract the zoom window horizontally, and the  or  arrow key to expand or contract the zoom window vertically, to encompass the event in question.
- Remember, the smaller the zoom window, the greater the detail when the waveform is zoomed. The arrow keys can also be used to expand and contract the screen after the event is zoomed.*
- Step 4.** Push the Zoom On softkey to zoom the event.
- The area within the zoom window expands to fill the screen.
- Step 5.** To cancel zoom and resume the waveform screen, push the Zoom Off softkey.

Real-Time and High-Density Testing

For real-time and high-density testing, the *Fiber Scan* setup in the *Test Setup* menu must be set to *Manual* mode, and the waveform should be zoomed.

Real-Time Testing. Real-time testing is useful when adjusting fiber connections and making splices because it immediately displays the results of work being done. New data is acquired quickly and the waveform is continually updated. Changes appear quickly on the screen.

Real-time testing can be done on either the full or zoomed waveform. However, to see more detail and for faster updating of the display, zoom the waveform.



CAUTION. *In real-time mode the laser fires continuously. Do not operate the TFS3031 in real-time mode unless a fiber is connected to the Laser Output port. Severe damage to internal electronics can result.*

High-Density Testing. High-density testing tests a specific section of the fiber at higher density (the sample points are closer together).

Test Procedure

Step 1. Put the TFS3031 in Manual fiber test mode.

1. Push the **Setup** softkey.
2. Change the *Fiber Scan* setup in the *Test Setup* menu to *Manual*.

Step 2. Push the **START/STOP** button to complete a test and display the waveform.

Step 3. Position the *active* cursor on the event (or other area of the waveform) that you want to test.

Step 4. Push the **SELECT** button to choose the *Zoom* option.

Step 5. Size the zoom window to encompass the event or area in question. The smaller the zoom window the faster the screen updates after zooming.

If necessary, refer to page 2–19 for information about sizing the zoom window.

Step 6. Push the **Zoom On** softkey. The area within the zoom window expands to fill the screen.

To begin a real-time test, *hold down* the **START/STOP** button for at least *two seconds*. The laser fires repeatedly, and waveform data is updated continually on the screen.

To stop a real-time test, push the **START/STOP** button.

To begin a high-density test, push the **START/STOP** button. Data is acquired at high density for the distance range displayed on the screen.

Allow a high-density test to finish normally.

Adding and Deleting User-Placed Events

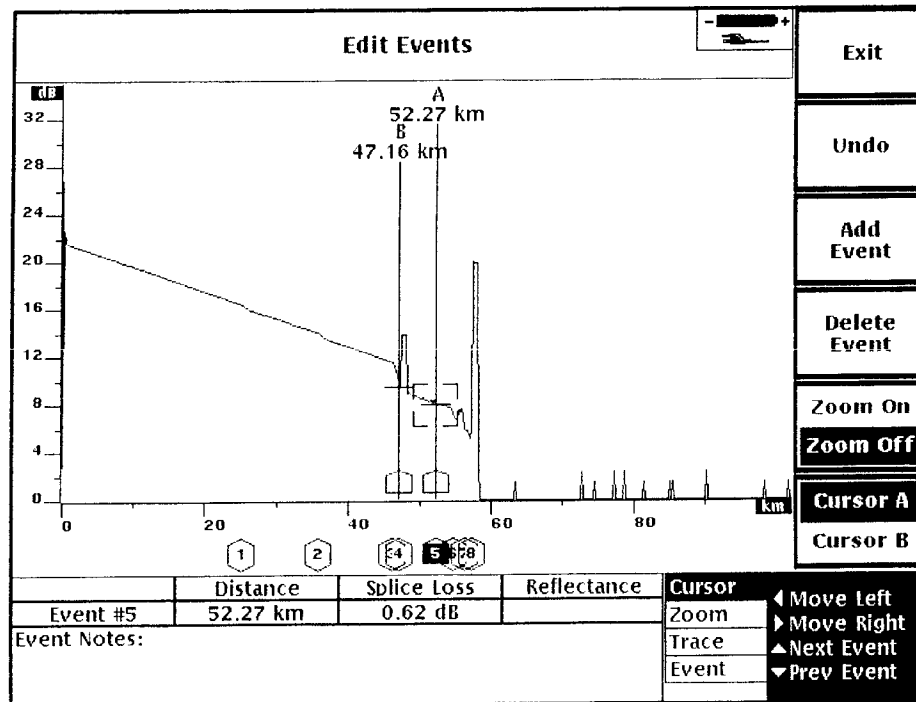

Figure 2–8: Typical User-Placed Event Screen. A New Event (5) is Added at the Location of Cursor A.

When the waveform screen is displayed, events can be added to the waveform, and existing events can be deleted from the waveform, by pushing the **Edit Events** softkey.

This feature is useful when marking a known point on the waveform that is not presently indicated. Examples may be the location of a fiber access point, a known trouble spot, an undetectable splice, or a known landmark.

Add/Delete User-Placed Event Procedure

Step 1. Complete a test and display the *waveform* screen.

Step 2. Push the **Edit Events** softkey. The **Undo**, **Add Event**, and **Delete Event** softkeys are now displayed.

SELECT button options include the *Event* option (along with the *Cursor*, *Zoom*, and *Trace* options).

Step 3. To add a new user-placed event, or delete an existing event:

1. Select the *Cursor* option.
2. Use the ◀ or ▶ arrow key to locate a point on the waveform to add an event, then push the **Add Event** softkey.

The ▲ and ▼ arrow keys jump the cursor to existing events to select them for deletion. Push the **Delete Event** softkey to delete an event.

A ◻ symbol indicates a user-placed event on the waveform screen and event table screen.

The **Undo** softkey undoes the most recent add/delete function.

Step 4. To edit or reposition an existing user-placed event:

1. Push the **SELECT** button to choose the *Event* option. The **Edit Event Notes** softkey is now displayed.
2. To add notes to an event, push the ▲ or ▼ arrow key to select the event, then push the **Edit Event Notes** softkey.

See page 2-26 for information about adding notes to events.

3. To reposition the currently selected event, push the ◀ and ▶ arrow keys to move the event back and forth along the waveform.

Step 5. When finished, push the **Exit** softkey to save and exit the add/delete/edit process and resume the waveform/table screen.

The waveform and table screens reflect any added or deleted events.

Adding Notes to Events

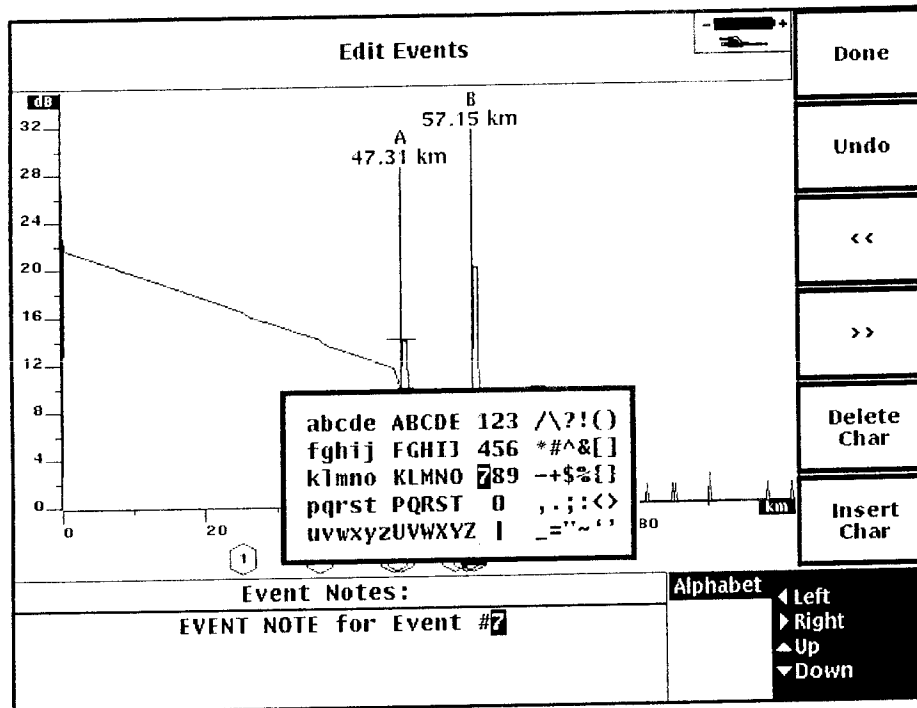

Figure 2–9: Typical Edit Events Screen

Event editing lets you add notes to events. Notes are displayed in the Event Notes box at the bottom of the screen, and are included when files are stored in memory, printed, or copied to a personal computer.

Notes can consist of anything including test data, reminders, comments, and operator information.

NOTE. *Editing the names of files is different from adding notes to events. To edit the names of files, push the Store or Print softkey and use the Save option. See page 2–32 for instructions about editing the names of files.*

Procedure to Add Notes to an Event

Step 1. Complete a test and display either the *waveform* or *event table* screen.

Step 2. Select the event to be noted.

Step 3. If the *event table* screen is displayed, skip to step 4.

If the *waveform* screen is displayed:

1. Push the **Edit Events** softkey.
2. Push the **SELECT** button to choose the *Event* option.

Step 4. Push the **Edit Event Notes** softkey.

A pop-up alphanumeric window appears on the screen, and an *Event Notes* box is displayed at bottom screen. Editing takes place in the Event Notes box. You can enter and edit notes using the optional keyboard, or by using the front-panel controls as described below.

The only **SELECT** button option is *Alphabet*.

- The *Alphabet* option enables use of the arrow keys to select characters from the alphanumeric window for inclusion in the Event Notes box.

Insert a character into the Event Notes box by pushing either the **SELECT** button or **Insert Char** softkey. The cursor advances to the next character position.

Delete a character from the Event Notes box by pushing the **Delete Char** softkey. The cursor moves to the previous character.

To move around in the Event Notes box for editing, push the **◀** softkey to move left or **▶** softkey to move right.

Other softkey options are:

- **Undo**. Aborts editing and restores the Event Notes box to its contents before editing began.

- Done. Saves and exits editing. Resumes the waveform/table screen.

File Storage

NOTE. This section describes how to save, load, copy, and delete files to and from internal memory and floppy disk (the Save, Load, Copy, and Delete options).

For information about printing files (the Print option) see “Printing Files” on page 2–43.

For information about copying files to a personal computer (also a part of the Copy option) see “Copying Files to a Personal Computer” on page 2–49.

Introduction

Before test results can be stored in memory, they must be displayed on the screen as either a waveform or event table. Both the waveform and event table can be stored together.

Push the **Store** or **Print** softkey to access the options for storing, printing, copying, and deleting files. Store/print options are displayed in the lower right corner of the screen (see Figure 2–10 on page 2–30).

Store/print options are:

- **Save.** Saves files in storage. Storage consists of 1.44 Mbyte internal memory or optional 1.44 Mbyte, 3.5 inch floppy disk.
- **Load.** Loads files from storage onto the screen for viewing.
- **Copy.** Transfers files between internal memory and floppy disk. The Copy option also copies files to a personal computer (see page 2–49).
- **Delete.** Deletes files from storage.
- **Print.** Prints files on an external printer (see page 2–43).

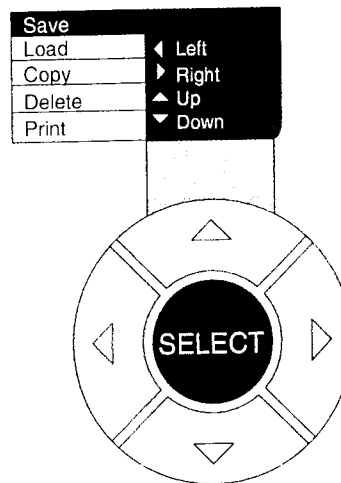

Figure 2–10: Store/Print Options

NOTE. Before using any of the store/print options, make sure that the proper memory source is selected by pushing the Internal/Floppy softkey.

Files that are loaded, copied, or printed are not deleted from storage. The only way to delete a file from storage is by using the Delete option.

Floppy Disk Formatting

When you access file storage by pushing the Store or Print softkey, if an unformatted floppy disk is in the disk drive, you are prompted to format the disk.

See “Formatting a Floppy Disk” on page 1–4 for disk formatting information.

File Storage Procedure

Save

Store/Print – Save					
Floppy:		2% Full	33K (of 1.46M)	14 Files	
FILE0001.CFF	FILE0002.CFF	FILE0003.CFF	FILE0004.CFF		
FILE0005.CFF	FILE0006.CFF	FILE0007.CFF	FILE0008.CFF		
FILE0009.CFF	FILE0099.CFF	NOTES1.TXT	NOTES2.TXT		
NOTES3.TXT	NOTES4.TXT				
Fiber Notes for Current Acquisition					
OPERATOR		Bill R.			
LOCATION		Downtown 5th & Wall			
FILE SETUP		CURRENT ACQUISITION		Save	
Filename:	FILE0002.CFF	Acquired:	<empty>	Load	◀ Left
Content:	Trace & Table	Content:		Copy	▶ Right
Format:	Tektronix			Delete	▲ Up
Auto Incr:	Name			Print	▼ Down

Figure 2–11: Typical Save Screen.

The Save option saves the current test data in storage. File content is based upon the file setups accessed by pushing the File Setup softkey.

The Save option also allows you to enter and edit fiber notes for the current acquisition. Fiber notes can be saved with the waveform or event table, or in a file alone, depending on the file-content selection.

Save softkey options are:

- **Save File.** Saves the current test data in storage (either internal memory or floppy disk).

- **File Setup.** Changes the setups that affect storage. File setups are File Content, File Format, and Auto Increment (displayed in lower left screen). *See page 1–36 for descriptions of these setups.*

Use the arrow keys to select and change file setups *before* saving the current test data in storage.

The **Done** softkey saves and exits file setup, and resumes the Save screen.

- **Edit File Name.** Edits the name of the file into which data is stored. The current file name is displayed in lower left screen. File names are limited to the MS-DOS *nnnnnnnn.eee* format.

The default file name is FILE0001.CFF. The “CFF” extension identifies Tektronix common file format files. Both the file name and extension can be changed. *See page 1–36 for information about how file names automatically change based on the Auto Increment setup.*

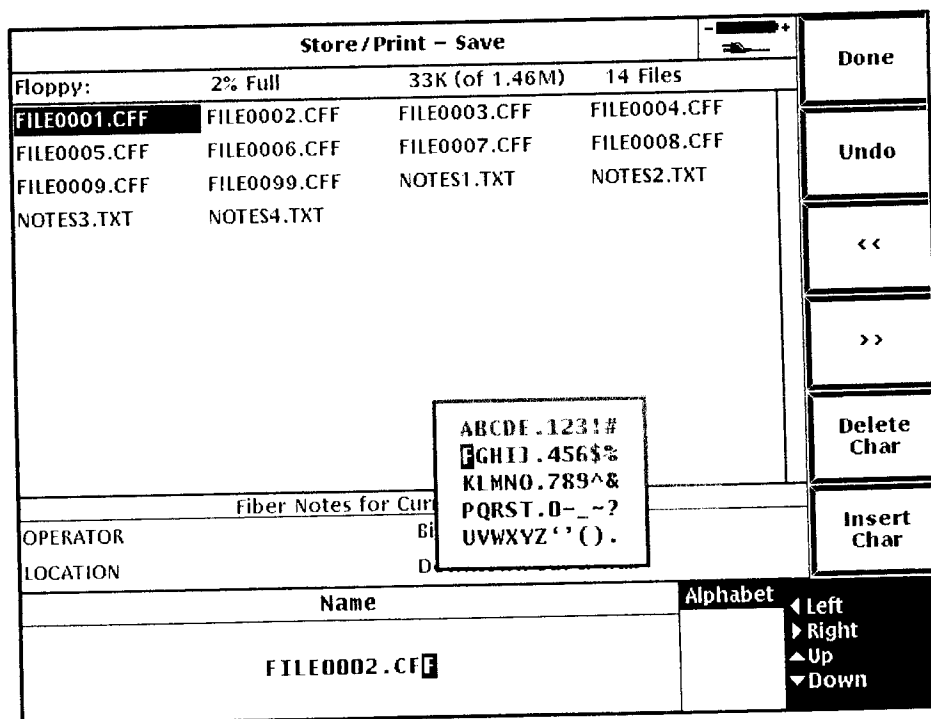

Figure 2–12: Editing the File Name.

When you push the **Edit File Name** softkey, a pop-up alphanumeric window appears on the screen, and a *Name* box is displayed at the bottom of the screen. Editing takes place in the Name box. You can enter and edit the file name using the optional keyboard, or by using the front-panel controls as described below.

The only **SELECT** button option is *Alphabet*.

- The Alphabet option enables use of the arrow keys to move around and select individual characters from the alphanumeric window for inclusion in the Name box.

Insert the selected character into the Name box by pushing either the **SELECT** button or **Insert Char** softkey. The cursor in the Name box advances to the next character position.

Delete a character from the Name box by pushing the **Delete Char** softkey. The cursor moves to the previous character.

To move around in the Name box for editing, push the **◀** softkey to move left or **▶** softkey to move right.

Other softkey options are:

- **Undo**. Aborts editing and re-establishes the original file name.
- **Done**. Saves and exits editing. Resumes the Save screen.
- **Edit Notes**. Allows you to view, enter, edit, and move fiber notes. These notes are saved with the waveform or event table to floppy disk or internal storage, and printed with the waveform or event table. You can also select to save the fiber notes alone into a file.

Enter or edit notes as follows:

1. Press the **Edit Notes** softkey to display the Edit Fiber Notes screen. This screen shows any existing fiber notes. The notes are numbered from 1 through 15 (maximum). Each note consists of two fields, the Title and the Description. You can edit both Title and Description fields, as well as move notes to reorder them.

2. Press the ▲ and ▼ arrow keys to select a row.
3. Press the Add Row softkey to enter a new note. A new, blank row is created after the highlighted row. The new row is now the currently selected row.
4. Press the ◀ and ▶ arrow keys to select the field to edit.
5. Press the Edit Field softkey to display a pop-up alphanumeric window on the screen. The field you are editing appears at the bottom of the screen. Edit the field using the optional keyboard, or by using the arrow keys and softkeys as described on the previous page for the file name. You can enter up to 23 characters in the Title field, and up to 55 characters in the Description field.
6. Press the Delete Row softkey to delete the current note.
7. Press Done to return to the Save screen.

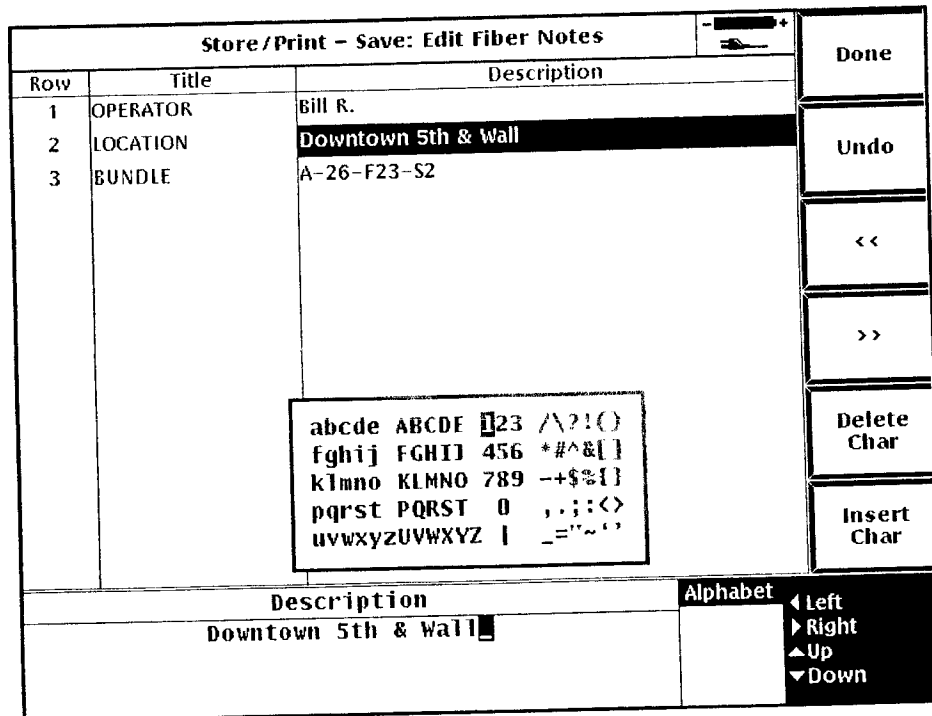

Figure 2-13: Editing a Fiber-Note Field.

Move notes as follows:

1. Press the **SELECT** button to select the Move option.
 2. Press the ◀ and ▶ arrow keys to select which row to move.
 3. Press the ▲ and ▼ arrow keys to move the selected row up or down. After the row is moved, the rows are renumbered.
 4. Press the **Done** softkey to return to the Save screen.
- **Internal/Floppy.** Selects the memory source in which the file will be saved.
 - **Exit.** Exits the Save screen. Resumes the waveform/table screen.

NOTE. *To maximize battery life when copying multiple files from internal memory to floppy disk, we recommend that you save all the files to internal memory first. Then copy all the files as a group to floppy disk using the **Copy All To Floppy** softkey, rather than saving files to floppy disk individually.*

*See page 2–39 for information about using the **Copy All To Floppy** softkey.*

Load

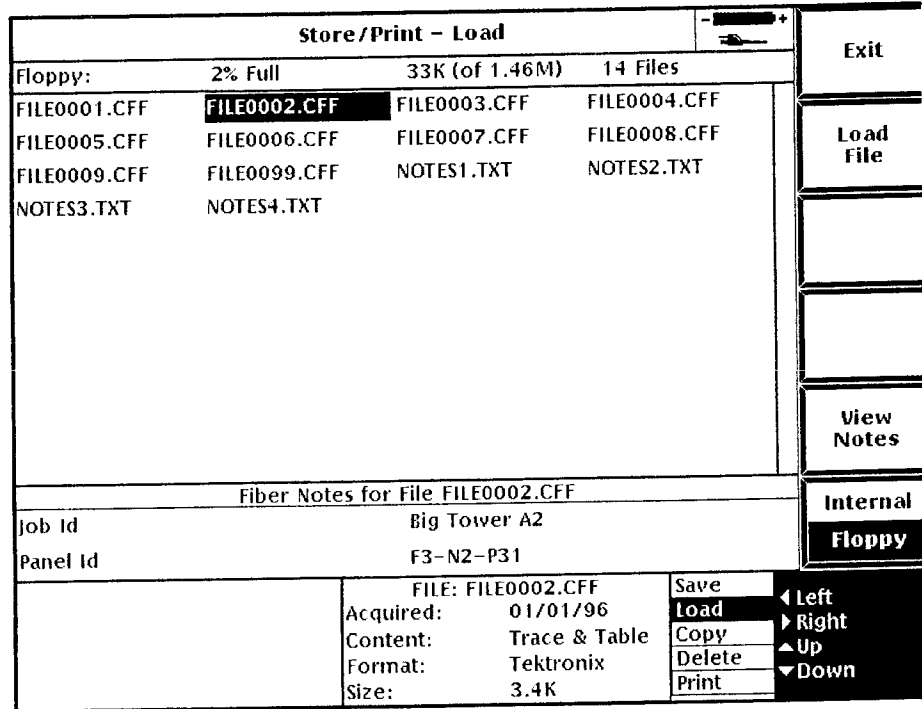

Figure 2-14: Typical Load Screen.

The Load option retrieves a file from storage and displays it on the screen. What gets loaded depends on file content (the value of File Content setup when the file was saved — see page 1-36).

Note that Text-formatted files other than fiber-note files cannot be loaded onto the screen.

When loading a waveform, event-table, or setup file the current test is cleared from the screen. Then the file contents in storage are loaded onto the screen as a new test.

If the *File Content* setup is set to *Trace, Table*, or *Table and Trace*, either or both the waveform and table are loaded along with associated test setups.

If the *File Content* setup is set to *Setups*, only instrument setups are loaded onto the screen. The waveform and event table displays are blank.

If the *File Content* setup is set to *Fiber Notes*, only fiber notes are loaded. The current test data is not cleared, but any existing fiber notes are overwritten.

Load softkey options are:

- **Load File.** Loads the selected file onto the screen.
Use the arrow keys to select the file before pushing the **Load File** softkey.
Push the **Exit** softkey to display the file after it has been loaded.
- **View Notes.** Displays the fiber notes (if any) for the selected file.
- **Internal/Floppy.** Selects the memory source that contains the file to be loaded.

Copy

Store/Print - Copy				Exit
Floppy:	2% Full	33K (of 1.46M)	14 Files	
FILE0001.CFF	FILE0002.CFF	FILE0003.CFF	FILE0004.CFF	Copy To Internal
FILE0005.CFF	FILE0006.CFF	FILE0007.CFF	FILE0008.CFF	Copy All To Internal
FILE0009.CFF	FILE0099.CFF	NOTES1.TXT	NOTES2.TXT	Copy To PC
NOTES3.TXT	NOTES4.TXT			
Fiber Notes for File FILE0001.CFF				Internal
OPERATOR	Bill R.			Floppy
LOCATION	Downtown			
	FILE: FILE0001.CFF	Save	Load	← Left
	Acquired: 01/01/96	Load	Copy	→ Right
	Content: Trace & Table	Copy	Delete	▲ Up
	Format: Tektronix	Delete	Print	▼ Down
	Size: 3.4K	Print		

Figure 2-15: Typical Copy Screen.

The Copy option copies files to a personal computer, and between internal memory and floppy disk.

Copy softkey options depend on whether internal memory or floppy disk is selected as the memory source (push the Internal/Floppy softkey first).

Copy softkey options are:

- **Copy To Internal.** Copies the file selected on floppy disk to internal memory.
- **Copy To Floppy.** Copies the file selected in internal memory to floppy disk.
- **Copy All To Internal.** Copies all files on floppy disk to internal memory.

- **Copy All To Floppy.** Copies all files in internal memory to floppy disk.
- **Copy To PC.** Copies either the selected file or all files to a personal computer.

See page 2–49 for information about copying files to a personal computer.

- **Internal/Floppy.** Selects the memory source from which file(s) will be copied, or the destination for files to be copied.
- **Exit.** Exits the Copy screen. Resumes the waveform/table screen.

NOTE. *To maximize battery life when copying multiple files from internal memory to floppy disk, we recommend that you save all the files to internal memory first. Then copy all the files as a group to floppy disk using the Copy All To Floppy softkey, rather than copying files to floppy disk individually.*

Delete

Store/Print - Delete				Exit
Floppy:	2% Full	33K (of 1.46M)	14 Files	
FILE0001.CFF	FILE0002.CFF	FILE0003.CFF	FILE0004.CFF	Delete Selected
FILE0005.CFF	FILE0006.CFF	FILE0007.CFF	FILE0008.CFF	Delete All Files
FILE0009.CFF	FILE0099.CFF	NOTES1.TXT	NOTES2.TXT	
NOTES3.TXT	NOTES4.TXT			View Notes
Fiber Notes for File FILE0002.CFF				Internal
Job Id	Big Tower A2			Floppy
Panel Id	F3-N2-P31			
	FILE: FILE0002.CFF	Save	◀ Left	
	Acquired: 01/01/96	Load	▶ Right	
	Content: Trace & Table	Copy	▲ Up	
	Format: Tektronix	Delete	▼ Down	
	Size: 3.4K	Print		

Figure 2-16: Typical Delete Screen.

The Delete option is the only way to delete files from storage.
Important: Deleted files cannot be recovered.

Delete softkey options are:

- **Delete Selected.** Deletes the file selected on the screen. Use the arrow keys to select a file before pushing the **Delete Selected** softkey.
- **Delete All Files.** Deletes all files from the specified storage medium.
- **View Notes.** Displays the fiber notes (if any) for the selected file.
- **Internal/Floppy.** Selects the storage medium from which file(s) will be deleted.

- **Exit.** Exits the Delete screen. Resumes the waveform/table screen.



Printing Files

The *Store/Print – Print* option prints test results displayed on the screen or test files stored in memory on a supported printer connected to either the 25-pin parallel port or 9-pin serial port. (Refer to 1–35 for information on printer setup and a list of supported printers.)

We recommend that you connect the printer to the parallel-port when possible. The print procedure described in this manual uses a Seiko DPU411 printer connected to the parallel port.

NOTE. *The Seiko DPU411 printer is not approved for use in countries requiring CE certification. Refer to the EC Declaration of Conformity at the front of this manual.*

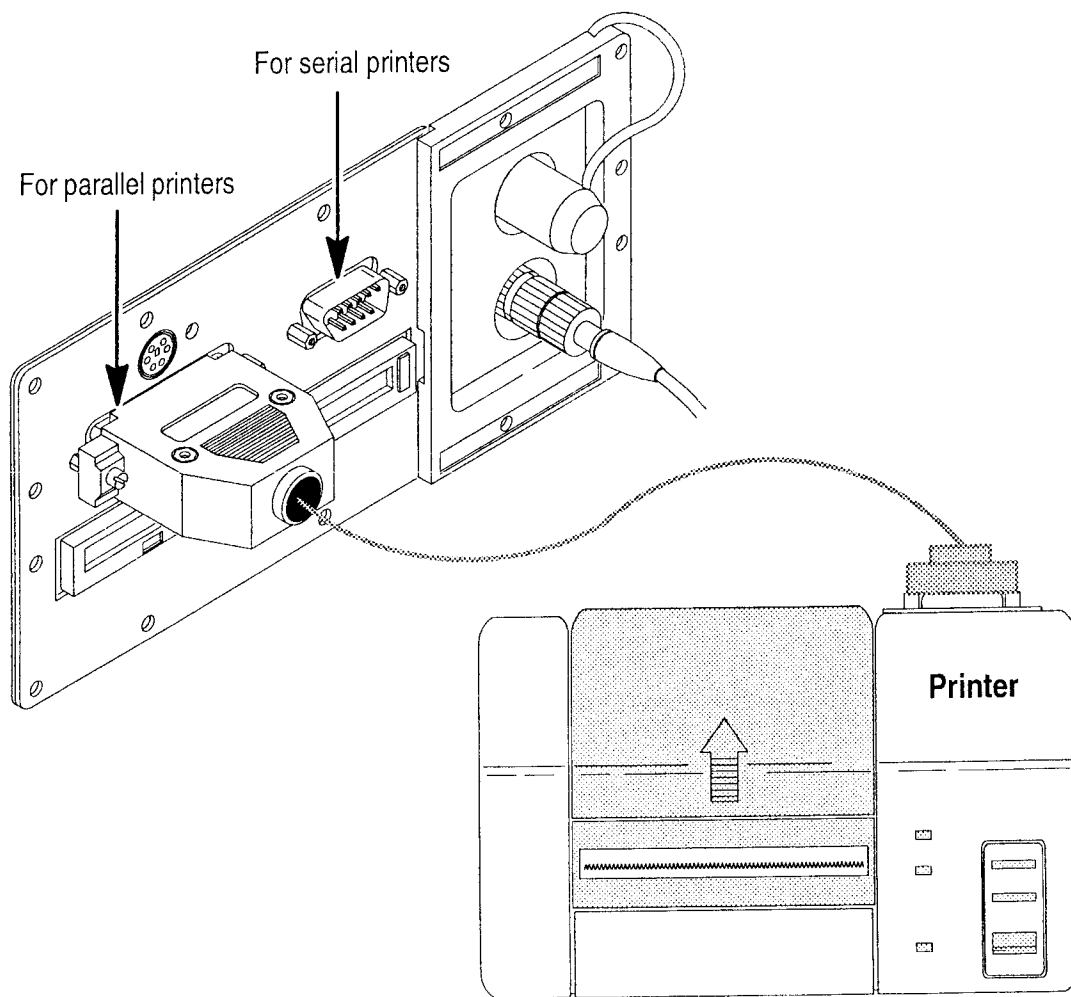

Figure 2-17: Seiko DPU411 Printer Connected to Parallel Port

Print Procedure

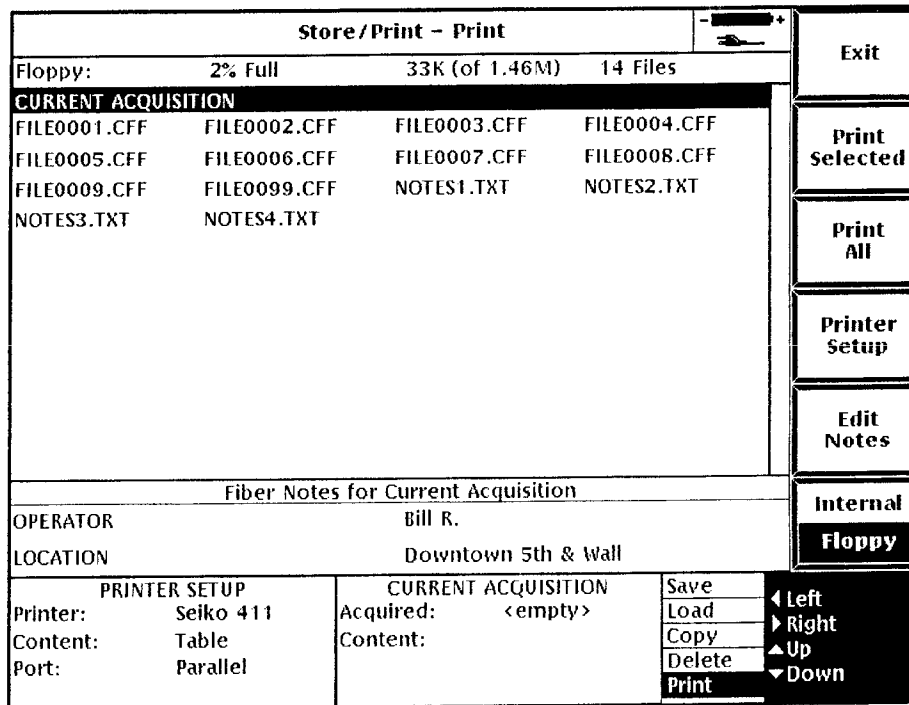
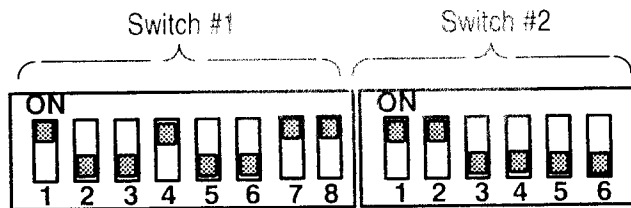

Figure 2-18: Typical Print Screen.

Step 1. When using a Seiko DPU411 printer with a parallel cable, set the switches on the bottom of the printer as shown:



Seiko DPU411 Switch Settings
for Parallel Interface

Seiko DPU411 Switch #1 – Parallel Cable	
Switch #	Function
1	On – Parallel/Serial Interface
2	Off – Carriage Return
3	Off – Condensed Printing
4	On – Ordinary Characters
5	Off – No Zero Font Setting
6, 7, 8	Off, On, On – English
Seiko DPU411 Switch #2 – Parallel Cable	
Switch #	Function
1	On – 8 Bits
2	On – No Parity Permission
3	Off – Even Parity Condition
4, 5, 6	Off, Off, Off – 9600 Baud

If using a Seiko DPU411 printer with a serial cable, Switch #1: 1 (Parallel/Serial Interface) should be set to Off. All other setups remain as shown in the table.

For other supported printers, use the setups as directed in each printer's user manual. When using the serial port, make sure the printer is set for eight bits and no parity.

Step 2. Connect the printer to the TFS3031 parallel port (or serial port), using the appropriate interface cable.

See Table 5-9 on page 5-7 for ordering printer cables.

See Table 5-4 on page 5-3 for information about serial cables.

Step 3. Power on the printer. Make sure the printer powers on properly.

Step 4. Power on the TFS3031. If necessary, complete a new test.

Step 5. Push the Store or Print softkey.

Step 6. Push the SELECT button to select the *Print* option.

Step 7. Push the Internal/Floppy softkey to select the memory source of the file to be printed, then use the arrow keys to select the file for printing.

To print a newly completed test that is not in memory, select the *Current Acquisition* file at the top of the screen.

Step 8. The first two fiber notes for the current file are displayed on the Print screen.

If the current acquisition is selected, you can enter and edit fiber notes for the current acquisition before printing, by pressing the **Edit Notes** softkey. Refer to page 2–33 for instructions on adding and editing fiber notes.

If a file on floppy disk or in internal memory is selected, the **Edit Notes** softkey is replaced by the **View Notes** softkey. Press the **View Notes** softkey to display all fiber notes for the selected file.

Step 9. Configure the TFS3031 for the printer in use.

Push the **Printer Setup** softkey. Use the arrow keys to select and change these setups:

- **Printer**

Select type of printer being used. Seiko DPU411 is the default.

- **Print Content**

When printing the *Current Acquisition* (current test), the Print Content setup determines printer output.

When printing a single file from storage, what gets printed depends on the Print Content setup, and file

content (the value of File Content setup when the file was saved – see page 1–36).

When printing all files in storage, the Print Content setup is ignored and only file content determines printer output.

■ External Port

Select Parallel or Serial port. If the Seiko DPU411 printer is configured as described in step 1, select the *Parallel* port.

■ Baud Rate

(Select 9600. Applies only if the Seiko DPU411 printer is connected to the serial port).

■ Flow Control

(Select RTS/CTS. Applies only if the Seiko DPU411 printer is connected to the serial port).

When through changing printer setups, push the Done softkey to resume the Print screen.

Step 10. Print the file by pushing one of these softkeys:

- **Print Selected.** Sends the file selected on the screen to the printer.

To stop printing the selected file before completion, push the **Abort Print** softkey. You may have to power the printer off and on again before you can print another file.

- **Print All.** Sends all files listed on the screen to the printer.

To stop printing all files before completion, power off the printer, and, in some cases, the TFS3031.

Step 11. When finished, push the **Exit** softkey to resume the waveform/table screen.



Copying Files to a Personal Computer

The *Store/Print – Copy* option copies files to a personal computer connected to the TFS3031 serial port.

Before a file can be copied, it must be stored in internal memory or floppy disk. This means that a newly acquired test displayed on the screen must first be stored in memory before it can be copied.

Either individual files or all the files currently in storage can be copied.

Also, the computer must have the Tektronix Test Data Storage (TDS) application software installed (or any communications program using YMODEM batch or YMODEM-g protocol).

NOTE. *TDS software is for copying files to a personal computer only. To view, analyze, and print files on the computer after copying, the computer must also have the Tektronix FMTAP trace analysis software installed.*

Both TDS and FMTAP software are Tektronix optional accessories (see *Optional Accessories* on page 5–8). The software includes complete user instructions.

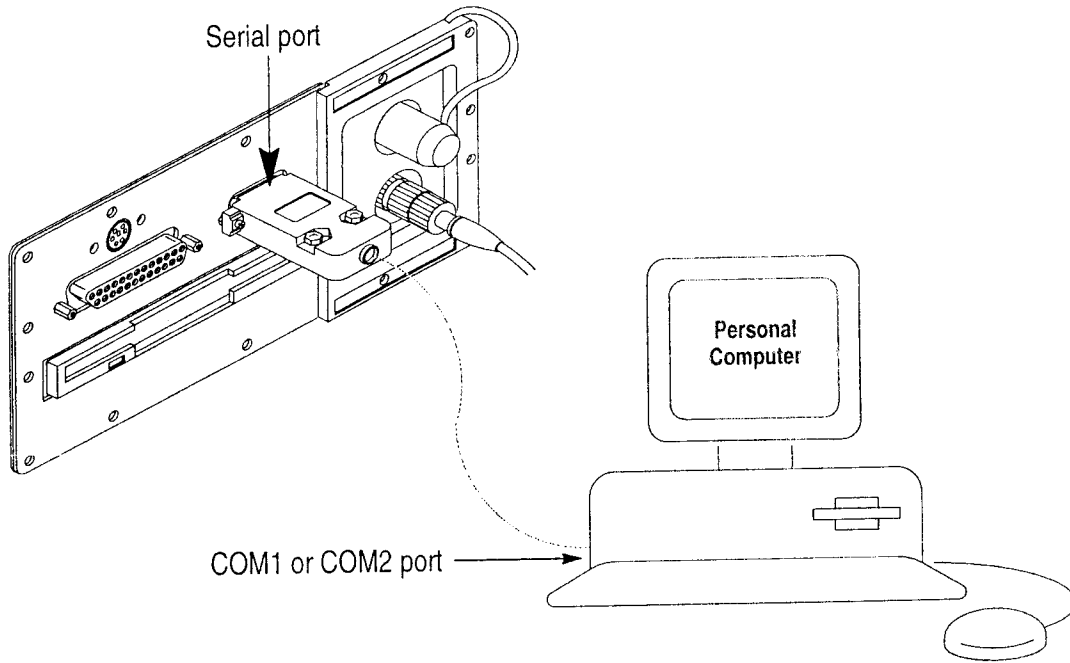

Figure 2–19: Computer Connected to TFS3031 Serial Port

NOTE. *The computer must be connected to the TFS3031 using a serial cable. See Table 5–4 on page 5–3 for information about serial cables.*

The TDS software package includes a serial cable.

Copy Procedure

Store/Print - Copy				Exit
Floppy:	2% Full	33K (of 1.46M)	14 Files	
FILE0001.CFF	FILE0002.CFF	FILE0003.CFF	FILE0004.CFF	Copy To Internal
FILE0005.CFF	FILE0006.CFF	FILE0007.CFF	FILE0008.CFF	Copy All To Internal
FILE0009.CFF	FILE0099.CFF	NOTES1.TXT	NOTES2.TXT	Copy To PC
NOTES3.TXT	NOTES4.TXT			
Fiber Notes for File FILE0001.CFF				Internal
OPERATOR	Bill R.			Floppy
LOCATION	Downtown			
	FILE: FILE0001.CFF	Save	← Left	
	Acquired: 01/01/96	Load	→ Right	
	Content: Trace & Table	Copy	▲ Up	
	Format: Tektronix	Delete	▼ Down	
	Size: 3.4K	Print		

Figure 2–20: Typical Copy To PC Screen.

NOTE. A newly acquired test displayed on the screen must first be stored in internal memory or floppy disk before it can be copied to a computer.

Complete a test and store it in memory before beginning this procedure.

- Step 1.** Establish TFS3031 setups that affect communication with the computer.
1. Push the **Setup** softkey when the waveform/table screen is displayed. Then push the **SELECT** button to access the *I/O–Doc Setup* menu.

2. Use the arrow keys to establish the following setups according to the requirements of your computer:
 - External Port
Select *Serial* port.
 - Baud Rate
Select baud rate as needed.
 - Flow Control
Set flow control as needed (*never set to XON/XOFF*).
3. Push the **Exit** softkey to resume the waveform/table screen.

Step 2. Access TFS3031 storage (internal memory or floppy disk) for file transfer.

1. Push the **Store** or **Print** softkey.
2. Push the **SELECT** button to choose the *Copy* option.
3. Push the **Internal/Floppy** softkey to access the appropriate storage medium.

Step 3. Push the **Copy To PC** softkey.

A pop-up message on the TFS3031 screen prompts you to prepare your computer for file transfer.

Step 4. To prepare your computer, connect the computer COM1 or COM2 port (COM1 is the default) to the TFS3031 serial port using the serial cable (an optional accessory – see Table 5-4 on page 5-3).

Step 5. Access the source directory in the computer for file transfer.

Step 6. Install the TDS application software in the computer.

Follow the TDS installation instructions that come with the software package. The TDS software contains a *readme.tds* file that explains how to use the TDS program.

- Step 7.** To copy files from the TFS3031 to the computer, use these softkeys:
- **Send Selected.** Copies the file selected on the screen to the computer. Use the arrow keys to select a file for copying.
 - **Send All Files.** Copies all files in storage to the computer.
 - **Abort Send.** Aborts copying. Resumes the Copy screen.
- Step 8.** When finished copying, push the **Exit** softkey to resume the waveform/table screen.

Recharging the NiCad Battery

Low-Battery Warning

The charge level of the battery is always displayed in upper right screen.

The first low-battery warning is a message displayed on the screen when about 30 minutes of normal operating time remain.

The second and last low-battery warning consists of a flashing *red* BATTERY LED on the front panel when about 10 minutes of normal operating time remain.

When to Recharge the NiCad Battery

Recharge the NiCad battery before using the TFS3031 on battery power, and when a low-battery warning is displayed.



A “battery” indicator that shows the charge level is always displayed in upper right screen. In this illustration the indicator shows that about 60% of battery power remains.

A “power plug” indicator is displayed below the battery indicator when the power/charger adapter or other external DC power source is connected to the instrument.



When the TFS3031 is using battery power, an estimate of the operating time left under *present operating conditions* is displayed in place of the power plug indicator.

The TFS3031 cannot be damaged by continuous charging over extended periods of time at ambient temperatures of less than 40° C (104° F). When the battery reaches full charge, the TFS3031 goes to trickle charge to maintain the full charge level.

Power/Charger Adapter

Use the power/charger adapter to recharge the battery (see Figure 3-1 on page 3-3). As long as the power/charger adapter is plugged into an active power source, the battery recharges whether the TFS3031 is powered on and operating, or powered off.

The power/charger adapter accommodates 110 to 240 volt AC source.

The power/charger adapter may also be used to power the TFS3031 when the battery is discharged or removed.



CAUTION. Do not connect the power/charger adapter to the TFS3031 when the ambient temperature exceeds 40⁰ C (104⁰ F).

Using a power/charger adapter other than the one supplied by Tektronix may damage the TFS3031.

The power/charger adapter is not hermetically sealed. Do not expose it to moisture.

An optional 12 volt cigarette lighter adapter lets you recharge the battery when in the field, or while driving to the work site.



CAUTION. Do not connect the cigarette lighter adapter cable to the TFS3031 when the ambient temperature exceeds 40⁰ C (104⁰ F).

NiCad Battery Recharging Procedure

To recharge the NiCad battery, plug the power/charger adapter into the port on the top of the TFS3031, and into an appropriate active power source (see Figure 3–1).

The battery recharges as long as the power/charger adapter remains connected to the instrument and power source.

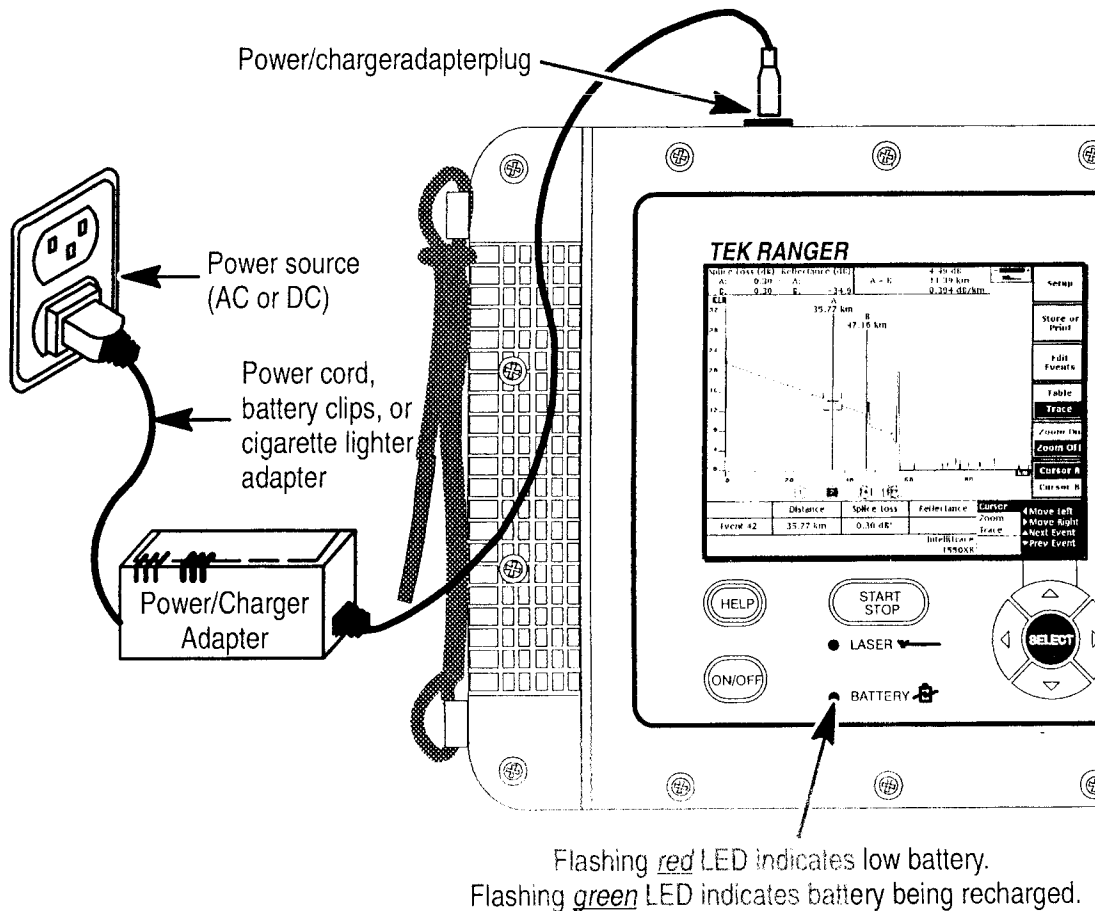

Figure 3–1: Typical NiCad Battery Recharging Setup



CAUTION. Do not connect the power/charger adapter to the TFS3031 when the ambient temperature exceeds 40⁰ C (104⁰ F).

To prevent overheating, remove the TFS3031 from its carrying case during recharging.

- A warning message flashed on the screen indicates that about 30 minutes of normal operating time remain.
- A flashing *red* BATTERY LED on the front panel indicates that about 10 minutes of normal operating time remain.
- The BATTERY LED flashes *green* when the power/charger adapter is connected and the battery is recharging.
- The BATTERY LED glows a steady *green* when the power/charger adapter is connected and the battery has reached full charge.
- The BATTERY LED is *off* when the power/charger adapter is disconnected.
- In the upper right corner of the screen, the “battery” indicator always shows charge level of the battery. A “power plug” indicator is displayed when the power/charger adapter is plugged in and charging the battery.
- Recharging time for a completely discharged NiCad battery at room temperature is about four hours if the TFS30301 is not turned on.
- Operating time for a fully recharged Nicad battery is about five hours.
- The TFS3031 may be powered on and operated during recharging. Recharging time will take longer if the TFS3031 is being operated.

Tips for Maximizing Battery Life

- Set a brief backlight blanking time using the *Backlight Time* setup in the *System Setup* menu.
- Set a brief automatic power-off time using the *Power Off Time* setup in the *System Setup* menu.

- Power off the 3031 when not in use.
- Save files to internal memory then copy them as a group to floppy disk rather than saving them directly to floppy disk. *See page 2–35 for more information about saving files.*

NiCad Battery Disconnection, Removal, and Replacement

- Step 1.** Turn off the TFS3031 and disconnect external power.
- Step 2.** Loosen the six screws that hold the battery compartment cover in place on the back of the instrument (see Figure 3–2 on page 3–6). The screws are captive to prevent loss.
- Step 3.** Disconnect the NiCad battery cable plug and lift the battery out of the case. The plug and connector snap together.
- The foam padding that surrounds the battery stays with the case.*
- Only the entire battery is replaceable. Individual cells are not replaceable.*
- Step 4.** Install the new battery by reversing the removal sequence.

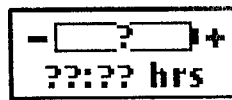

When a NiCad battery is disconnected then reconnected, or a new NiCad battery is installed, the battery indicator in upper right screen displays question marks until full recharge or discharge is reached. The question marks are also displayed for about 10 seconds when the unit is first turned on, as well as when the AC adapter is unplugged, until a valid time estimate is calculated.

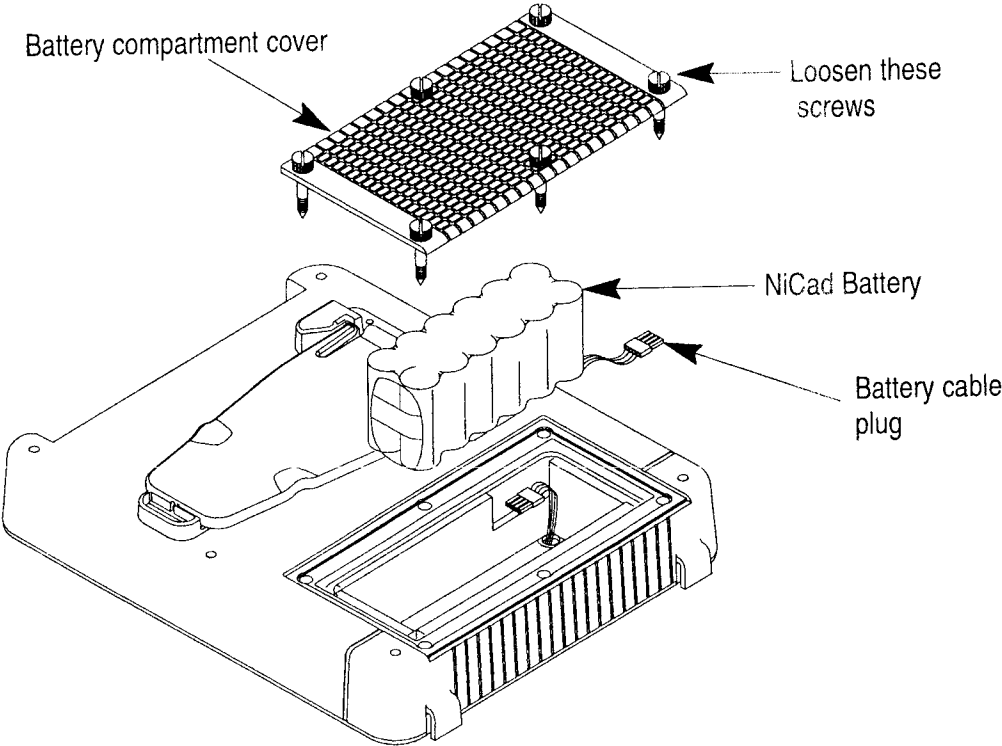

Figure 3-2: NiCad Battery Disconnection, Removal and Replacement

Cleaning



CAUTION. *Clean the optical connections before testing a fiber.*

Do not touch the exposed end of the Laser Output port or fiber connector with anything but a lint-free swab or paper wipe dampened with electronics-grade alcohol.

Turn off the instrument and disconnect the power/charger adapter before beginning any cleaning procedure.

Do not use index matching fluid or gel on the Laser Output port or fiber connector. It may cause contamination and a fatal error message. If index matching material is inadvertently used, clean the Laser Output port and fiber connector thoroughly.

Do not use acetone on optical connectors.



WARNING. *INVISIBLE LASER RADIATION. To eliminate hazardous radiation exposure do not use controls or adjustments, or perform procedures, other than those specified in this manual.*

Cleaning Materials

- Dust-free canned air
- Lint-free swabs or paper wipes
- Lint-free pipe cleaners (0.35 cm [0.15 inch] diameter)
- Electronics-grade alcohol

Exposing the Laser Output Port for Cleaning

Remove the connector adapter by unscrewing it *counterclockwise* and pulling it off the Laser Output port.

When the connector adapter is removed the Laser Output port is accessible for cleaning.

NOTE. *The connector adapter and Laser Output port are keyed for proper mating during reinstallation.*

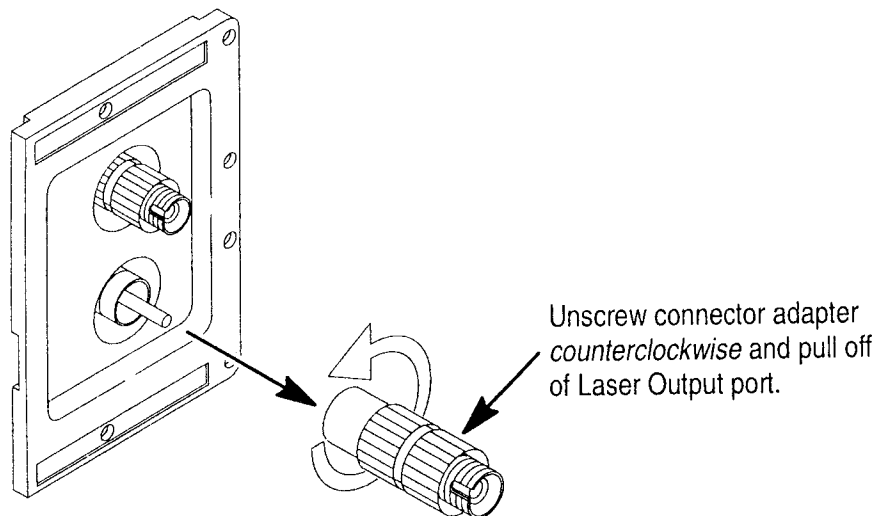

Figure 4–1: Exposing the Laser Output port for Cleaning

Cleaning the Laser Output Port

Dampen a lint-free swab or paper wipe with electronics-grade alcohol, and gently wipe across and around the port a couple of times.

Dry with a dry swab or dry portion of the paper wipe.

If the port is extremely dirty repeat the procedure with a second lint-free swab or paper wipe.

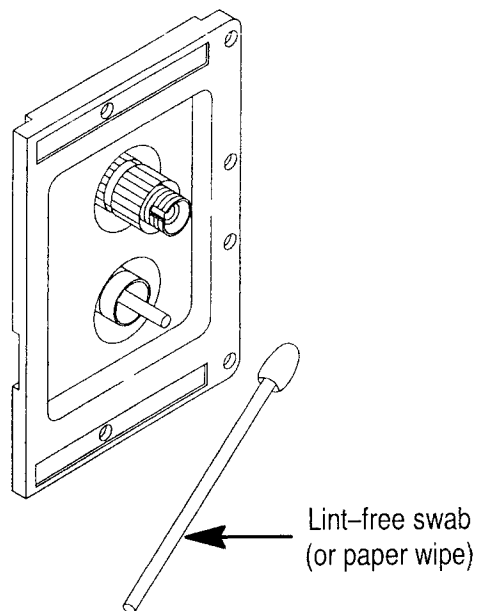

Figure 4-2: Cleaning the Laser Output port

Cleaning the Connector Adapter

- Step 1.** Blow through each end of the connector adapter barrel with dust-free canned air (see Figure 4-3).
 - Step 2.** Dampen a lint-free pipe cleaner with electronics-grade alcohol. The pipe cleaner absorbent should be about 0.35 cm (0.15 inch) in diameter, and the wire part of the pipe cleaner should be less than 0.1 cm (0.04 inch) in diameter.
 - Step 3.** Gently insert the dampened pipe cleaner into the barrel of the connector adapter. Be careful not to scratch the barrel with the wire while inserting it.
 - Step 4.** Pull the pipe cleaner completely through the barrel.
 - Step 5.** Blow the barrel completely dry with dust-free canned air.
- If the connector adapter is extremely dirty repeat the procedure with a second pipe cleaner.

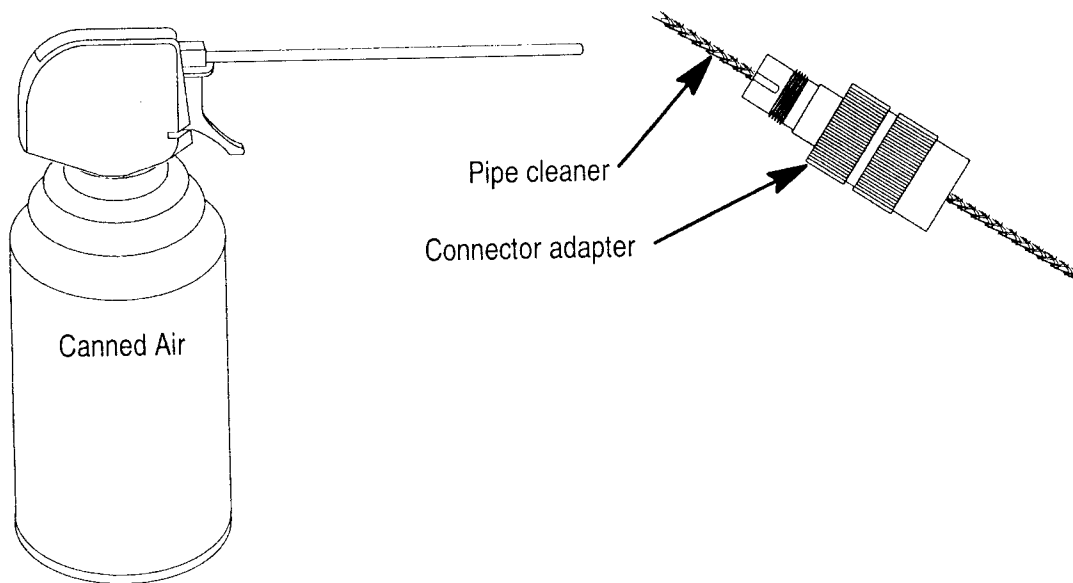

Figure 4-3: Cleaning the Connector Adapter

Cleaning the Fiber Connector

Dampen a lint-free swab or paper wipe with electronics-grade alcohol, and gently wipe across and around the connector a couple of times.

Dry with a dry swab or dry portion of the paper wipe.

If the connector is extremely dirty repeat the procedure with a second lint-free swab or paper wipe.

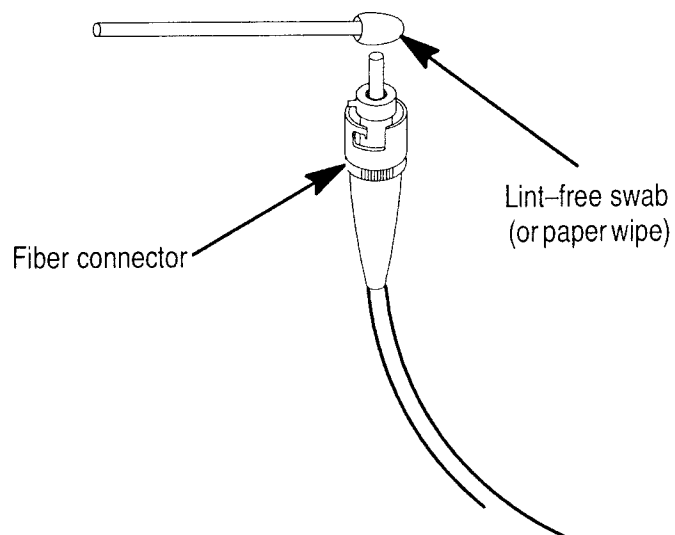

Figure 4-4: Cleaning the Fiber Connector

Troubleshooting

NOTE. Before attempting any repairs first recharge the battery fully, or try powering the instrument using the power/charger adapter.



CAUTION. Do not remove any covers or panels on the TFS3031 except to access the battery. Refer all repair problems to Tektronix service.

Refer to page xiii in the “Preface” for phone numbers to call for service help.

TFS3031 Does Not Power On

If the TFS3031 will not power on, or powers on with a blank screen, the battery may be discharged.

Recharge the battery, or try powering the instrument with the power/charger adapter.

If this does not solve the problem, contact Tektronix service.

If the TFS3031 will not power on when the battery is fully charged, disconnect the battery cable for one minute. Then reconnect the cable and power-on the instrument. See page 3–5 for battery disconnection/reconnection procedure.

Error Message Resolution

Front Panel Connection Status

If a message involving the status of the front panel connection appears on the screen after pushing the START/STOP button, follow directions in the message.

If the message reappears, either continue using the TFS3031 at reduced efficiency (push the OK softkey to continue testing, or the STOP button to stop testing), or contact Tektronix service.

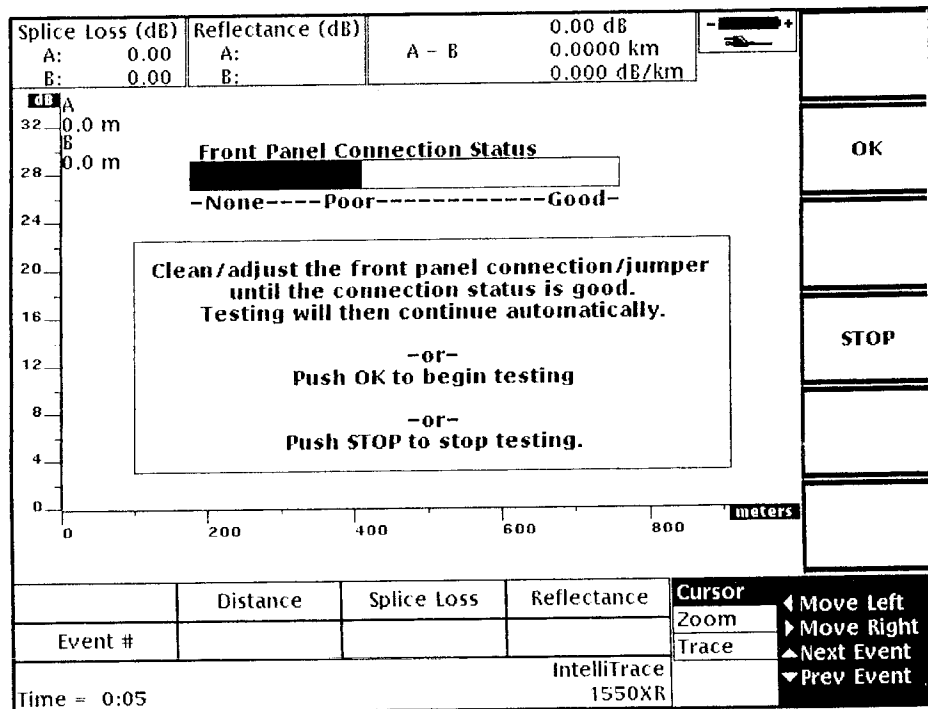

Figure 4-5: Example Front Panel Connection Status Message

Self Test Error Message

If an error message appears during the power-on self test sequence, try turning the TFS3031 off and on again.

If the error message reappears, do not continue using the instrument. Note the error message and contact Tektronix service.

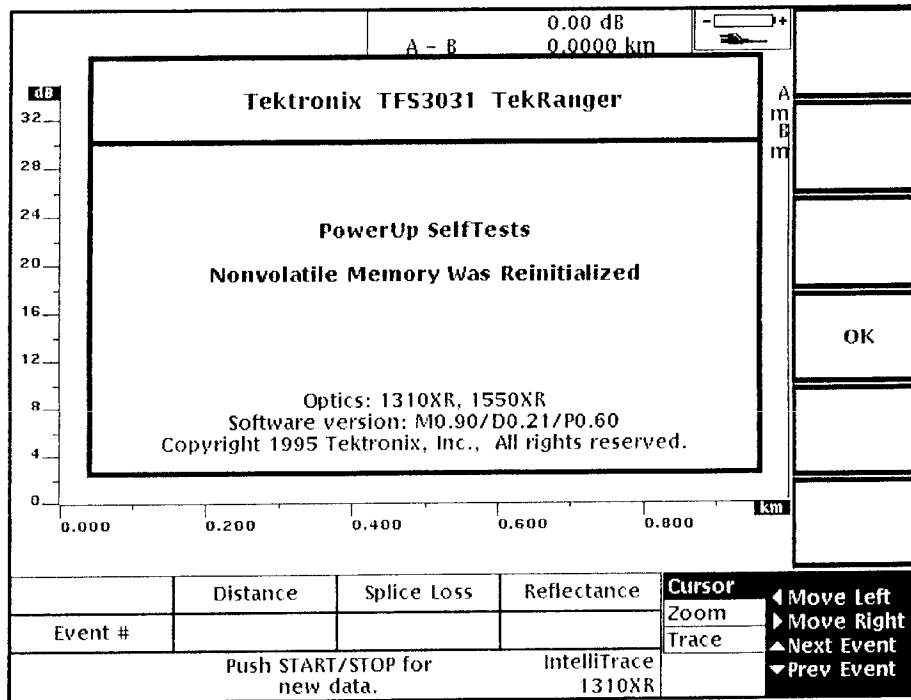

Figure 4–6: Example Self Test Error Message

Fatal Error Code

If a three-digit fatal error code appears during normal operation of the TFS3031 there is an internal hardware problem.

Try turning the TFS3031 off and on again. If the error code reappears, do not continue using the instrument. Note the error code and contact Tektronix service.

Specifications

Table 5–1: Laser Output

Specification	Characteristic
Laser Output Characteristics	
850 nm Multimode	850 ± 30 nm
1300 nm Multimode	1300 ± 30 nm
1310 nm Singlemode	1310 ± 20 nm
1550 nm Singlemode	1550 ± 20 nm
Loss Threshold	
Singlemode	0.02 dB minimum
Multimode	0.1 dB minimum
Loss Resolution	0.001 dB
Distance Resolution	0.25 m (0.8 foot)
Display Measurement Range	
Distance	0.001 km to 160 km (99.5 miles)
Loss	0.001 dB to 22 dB
Measurement Time (IntelliTrace)	Less than 3 minutes (20 dB accumulated loss)
Dead Zone	
Singlemode	
Event Detection	5 m (16.4 feet)
Loss Measurement	25 m (82.0 feet)
Multimode	
Event Detection	<5 m (<16.4 feet)
Loss Measurement	10 m (32.8 feet)

Table 5-1: Laser Output (Cont.)

Specification	Characteristic
Selectable Pulsewidths Singlemode Multimode 850 nm 1300 nm	Meters: 1, 5, 10, 20, 50, 100, 500, 1000, 2000 Feet: 3.3, 16.4, 32.8, 65.6, 164, 328, 1640, 3280, 6560 Meters: 1, 5, 10 Feet: 3.3, 16.4, 32.8 Meters: 1, 5, 10, 20, 50, 100 Feet: 3.3, 16.4, 32.8, 65.6, 164, 328
Dynamic Range (SNR=1) 850 nm MM (Opt 01) 850/1300 nm MM (Opt 03) 1310 nm SM (Opt 04) 1310/1550 nm SM (Opt 06) 1310/1550 nm SM (Opt 08) 1550 nm SM (Opt 09)	25.5 dB 25.5/21.5 dB 26 dB 26/24 dB 30/28 dB 30 dB
Measurement Range (Bellcore TR-001138) 850 nm MM (Opt 01) 850/1300 nm MM (Opt 03) 1310 nm SM (Opt 04) 1310/1550 nm SM (Opt 06) 1310/1550 nm SM (Opt 08) 1550 nm SM (Opt 09)	22 dB 22/20 dB 21 dB 21/19 dB 25/23 dB 25 dB

Table 5–2: Power

Specification	Characteristic
NiCad Battery	
Rating	14.4 V, 2.8 amp/hr
Charge Time (Discharged)	4 hours (nonoperating)
Typical Battery Life	
Normal Use	4.5 hours typical
Shelf Life (In Instrument)	70% after 1 mo at 20° C (68° F) 50% after 8 days at 50° C (122° F)
Storage Temperature	–30° to 50° C (–26° to 122° F)
Power/Charger Adapter Output	15.5 VDC, 43 W maximum
DC Input	9 to 16 VDC, 43 W maximum

Table 5–3: Size and Weight

Specification	Characteristic
Weight	
Single-port instrument w/battery plus standard accessories	<4.31 kg (<9.5 pounds) <5.90 kg (<13 pounds)
Dual-port instrument w/battery plus standard accessories	<4.77 kg (<10.5 pounds) <6.22 kg (<13.7 pounds)
Dimensions	29.21 x 11.43 x 24.1 cm (11.5 x 4.5 x 9.5 inches)

Table 5–4: RS232 Serial Port

Requirement	Specification
DB9 Configuration as DTE	EIA–RS232C IBM AT male
Flow Control	None, RTS/CTS, XON/XOFF, DTR
Baud Rate	1200, 2400, 4800, 9600, 19200, 38400 bps

Serial Cable Information

You must use a serial cable to connect the TFS3031 to a personal computer. Use either the Tektronix cable listed as an optional accessory (see Table 5-9 on page 5-7), or build your own serial cable based upon the pinout table on page 5-4. The TFS3031 serial port matches a PC/AT DB9 cable exactly.

A serial cable can also be used with the TFS3031-compatible printers. However we recommend using parallel cables for printers whenever possible.

Serial Cable Build Procedure		
From TFS3031 (Male DB9)	To Seiko (Female DB25)	To Epson (Female DB25)
1 DCD (Input)		
2 RD (Input)		
3 TD (Output)	2 RD (Input)	3 RD (Input)
4 DTR (Output)		
5 GND	7 GND	7 GND
6 DSR (Input)		
7 RTS (Output)		
8 CTS (Input)	5 BUSY (Output)	20 DTR (Output)
9 RI (Input)		

With the hardware flow control (CTS) connected, set the *Flow Control* setup to *RTS/CTS*, and the *Baud Rate* setup to the fastest rate that the printer can support (Seiko DPU411 is 9600 baud). These setups are available both in the IO-Doc Setup menu and the Store/Print – Print option.

Without CTS connected, the fastest baud rate that the Seiko can support is 2400.

Maximum baud rate without flow control for an Epson-compatible printer depends on the printer.

Table 5-5: Parallel Port

Requirement	Specification
25-Pin D Subminiature	Standard PC parallel cable

Table 5-6: Keyboard

Requirement	Specification
6-pin mini-DIN PS2-style connector	IBM PC-AT type

Table 5-7: Environmental

Specification	Performance Requirement
Temperature Without Disk Drive Operating ^{1,2} Nonoperating ³ With Disk Drive Operating ^{1,2} Nonoperating ³	0° to 40° C (32° to 104° F) -20° to 60° C (-4° to 140° F) 5° to 40° C (41° to 104° F) -20° to 60° C (-4° to 140° F)
Relative Humidity Without Disk Drive Operating Nonoperating With Disk Drive Operating Nonoperating	10 to 95% relative humidity, noncondensing 10 to 95% relative humidity, noncondensing 20 to 80%, noncondensing 10 to 85% noncondensing
Altitude (Maximum) Operating Nonoperating	4.6 km (15,000 feet) 15.2 km (50,000 feet)
Water Resistance	Drip proof

Table 5-7: Environmental (Cont.)

Specification	Performance Requirement
Dust Resistance	Instrument is dust resistant by design
Free-Fall Drop (Nonoperating)	Height: 30 inches Orientation: on its back Surface: concrete Duration: 1 drop Bellcore TR-NWT-001138, paragraph 5.2.1.3

¹ The TFS3031 must stabilize for about 15 minutes at the ambient temperature before testing if stored outside of operating temperature range.

² The maximum ambient temperature when charging the NiCad battery is +40° C (104° F). Do not charge the NiCad battery for long periods while the TFS3031 is in its carrying case.

³ The maximum storage temperature for the NiCad battery is +50° C (122° F).

Accessories and Options

Table 5–8: Standard Accessories

Accessory	Tektronix Part Number
User Manual	070–9027–xx
Reference Card	063–2096–xx
Power/Charger Adapter USA, Canada, UK, Europe only or Japan only	119–4545–00 119–4895–00
Power Cord for Power/Charger Adapter 120 Volt USA and Canada only or 100 Volt Japan only	161–0228–00 161–0288–00
Soft Carrying Case	016–1215–01
Shoulder Strap for Soft Carrying Case	346–0284–00

Table 5–9: Optional Accessories

Accessory	Tektronix Part Number
Power Cord for Power/Charger Adapter 220 V Europe (Option A1) 240 V UK (Option A2) 240 V Australia (Option A3) 220 V Switzerland (Option A5) 100 V Japan (Option A6)	161–0066–09 161–0066–10 161–0066–11 161–0154–00 161–0288–00
Spare NiCad Battery	146–0112–00
Hard Travel Case	016–1210–00

Table 5-9: Optional Accessories (Cont.)

Accessory	Tektronix Part Number
RS232C Serial Cable (2 Meters Long) for PC/AT DB9F/DB9F Null	012-1379-00
DB25/Centronics Parallel Printer Cable, Seiko Style (3 Meters Long)	012-1214-00
TDS (Test Data Storage) Software for Personal Computer (Includes Serial Cable and User Instructions)	FSTIP
FMTAP Trace Analysis Software for Personal Computer (Includes User Instructions)	FMTAP
12 Volt Battery Clips (for Power/Charger Adapter)	198-5809-00
Cigarette Lighter Adapter (for Power/Charger Adapter)	198-5810-00
Service Manual (Module Level)	070-9026-01
Seiko DPU411 Printer with 120 Volt Adapter	HC411 03*
Seiko DPU411 Printer with 220 Volt European-Style Adapter	HC411 03 A1*
Keyboard (for upgraded instruments and instruments with serial numbers B030000 and above)	118-9402-00

* Not approved for use in countries requiring CE certification. Refer to EC Declaration of Conformity at the front of this manual.

Table 5-10: Power/Charger Adapter Cord Options

Option Number	Power Cord
A1	220 V Europe
A2	240 V UK

Table 5–10: Power/Charger Adapter Cord Options (Cont.)

Option Number	Power Cord
A3	240 V Australia
A5	220 V Switzerland
A6	100 V Japan

Table 5–11: Laser Output Port Options

Option Number	Laser Output Port
01	850 nm Multimode
03	Dual-Wavelength 850/1300 nm Multimode
04	Standard 1310 nm Singlemode
06	Standard Dual-Wavelength 1310/1550 nm Singlemode
08	Extended Range Dual-Wavelength 1310/1550 nm Singlemode
09	Extended Range 1550 nm Singlemode

Table 5–12: Connector Adapter Options

Option Number		Connector Adapter	Tektronix Part Number
Singlemode	Multimode		
30	20	Biconic	119-4515-00
31	21	FCPC	119-4516-00
32	22	D4PC	119-4514-00
34	24	STPC	119-4513-00
35	25	DINPC 47256	119-4546-00
36	26	Diamond 3.5	119-4558-00

Table 5-12: Connector Adapter Options (Cont.)

Option Number		Connector Adapter	Tektronix Part Number
Singlemode	Multimode		
38	28	SCPC	119-4518-00
41	—	FC/APC ¹	119-5115-00
42	—	SC/APC ¹	119-5116-01

¹ Angle polish connector adapters (singlemode options 41 and 42) cannot be interchanged with any of the other connector adapters.

Table 5-13: Instrument Configuration Options

Option Number	Instrument includes:
1I	3.5 inch floppy disk drive
1S	FMTAP/FSTIP software
1T	Hard transit case
1R	19 inch rackmount configuration
19	Keyboard
2T	TOP130 LED source 850/1300 nm, ST
3T	TOP140 laser source 1310 nm, FC
4T	TOP150 laser source 1550 nm, FC
5T	TOP200 optical power meter 850/1300/1550 nm, ST
6T	TOP300 visual fault finder 635 nm, FC
7T	TOP160 laser source 1310/1550 nm, FC
L1	French language option (includes French user manual 070-9507-xx and quick-reference card 063-1839-xx)
L2	Italian language option (includes Italian user manual 070-9587-xx and quick-reference card 063-1843-xx)

Table 5-13: Instrument Configuration Options (Cont.)

Option Number	Instrument includes:
L3	German language option (includes German user manual 070-9588-xx and quick-reference card 063-1993-xx)
L4	Spanish language option (includes Spanish user manual 070-9589-xx and quick-reference card 063-1837-xx)
L5	Japanese language option (includes Japanese user manual 070-9590-xx)
L6	Portuguese language option (includes Portuguese user manual 070-9593-xx and quick-reference card 063-1842-xx)
L7	PRC Chinese language option (includes PRC Chinese user manual 070-9591-xx)
L8	Standard Chinese language option (includes Standard Chinese user manual 070-9592-xx)
LF	Finnish language option (includes Finnish user manual 070-9689-xx and quick-reference card 063-2553-xx)

Keyboard Definitions

The functions of the TFS3031's front-panel controls can be duplicated using an optional keyboard connected to the keyboard connector (on upgraded instruments and instruments with serial numbers B030000 and above).

The instrument accepts text entry from the keyboard whenever a character-selection box is on the display (i.e., when entering fiber notes, a file name, or event notes). Table 5-14 lists the keyboard's text-entry functions.

Table 5-14: Text-Entry Functions

Key	Function
Backspace	Delete the character to the left of the cursor
Delete Del (keypad)	Delete the character that the cursor is on
Home	Move the cursor to the beginning of the text being edited
End	Move cursor to the end of the text being edited
Page Down	Delete all characters from the cursor to the end of the text being edited
←→	Move the cursor to the left and right
Esc	Undo
Return	Done

When the instrument is not in text-entry mode, you can duplicate the front-panel functions listed in table 5–15.

Table 5–15: Front-Panel Functions

Key	Function
F1 through F6	Perform the same function as the corresponding front-panel softkey, as currently labeled. F1 corresponds to the top softkey, F2 to the second softkey from the top, etc.
Alt-? Alt-/	Help
Alt-S	Start/Stop
Alt-R	Start a real-time acquisition
Alt-J	Join cursors
F10 Return	Select

Index

A

- Abort Print softkey, 2-48
- Abort Send softkey, 2-53
- accessories
 - optional, 5-7
 - power cord options, 5-8
 - standard, 5-7
- Add Event softkey, 2-24
- Add Row softkey, 2-34
- application information. *See* help information
- arrow keys, 1-7, 1-16, 2-6, 2-11, 2-17, 2-20, 2-24, 2-27, 2-33, 2-47, 2-52
- auto increment setup, 1-37
- averages setup, 1-21

B

- backlight time setup, 1-31
- battery
 - charger indicator, 3-1
 - low-battery warning, 3-1
 - new battery indicator, 3-5
 - NiCad recharging procedure, 3-3
 - NiCad recharging setup, 3-3
 - NiCad recharging time, 3-4
 - NiCad removal/replacement, 3-5
 - power/charger adapter description, 3-2
 - power-saving tips, 3-4
 - time indicator, 3-1
- baud rate setup, 1-34

C

- cleaning
 - accessing laser output port, 4-2
 - cautionary notes, 4-1
 - connector adapter, 4-4
 - fiber connector, 4-5
 - laser output port, 4-3
 - materials, 4-1
- company name setup, 1-36
- connector adapter
 - cleaning, 4-4
 - description, 1-2
 - installation and removal, 1-2
 - options, 5-9
- contrast adjust setup, 1-31
- Copy All To Floppy softkey, 2-39
- Copy All To Internal softkey, 2-38
- Copy To Floppy softkey, 2-38
- Copy To Internal Softkey, 2-38
- Copy To PC softkey, 2-39, 2-52
- cumulative loss setup, 1-28
- Cursor A/Cursor B softkey, 2-10, 2-15
- cursor A-B setup, 1-26
- cursor option, 2-17
- cursors
 - description, 2-15
 - fiber test procedure, 2-5
 - joining, 2-16
 - moving the cursors, 2-17

D

- date format setup, 1–32
- date setup, 1–32
- dead zone setup, 1–28
- default setups
 - factory setups, 1–33
 - last used setups, 1–33
 - Save Latest User Setup softkey, 1–33
- Delete All Files softkey, 2–40
- Delete Char softkey, 2–27, 2–33
- Delete Event softkey, 2–24
- Delete Row softkey, 2–34
- Delete Selected softkey, 2–40
- distance delta setup, 1–29
- distance scale, waveform screen, 2–8
- distance setup, 1–27
- distance tolerance setup, 1–29
- distance units setup, 1–24
- Done softkey, 2–27, 2–33

E

- Edit Company Name softkey, 1–36
- Edit Event Notes softkey, 2–24
- Edit Events softkey, 2–9, 2–23
- Edit Field softkey, 2–34
- Edit File Name softkey, 2–32
- Edit Notes softkey, 2–33
- End of Fiber mode, 1–20
- end of fiber threshold setup, 1–22
- environmental specifications, 5–5
- Epson printer, 1–35
- error code, fatal error, 4–9
- error message
 - front panel connection status, 4–8
 - self test, 4–8
- event markers, 2–8

- event notes, procedure, 2–27
- event option, adding user-placed events, 2–24
- event setup, 1–25
- event table
 - selecting an event, 2–18
 - viewing the table, 2–18
- event table screen, 2–11
- events
 - adding and deleting, 2–24
 - user placed, 2–23
- Exit to Event softkey, 2–12
- external port setup, 1–35

F

- fiber connector, cleaning, 4–5
- fiber notes, 2–13
 - adding, 2–34, 2–47
 - deleting, 2–34
 - editing, 2–33, 2–47
 - editing in a text file, 1–37
 - loading from a file, 2–37
 - moving, 2–35
- fiber scan setup
 - End of Fiber mode, 1–20
 - IntelliTrace mode, 1–19
 - Manual mode, 1–20
- fiber test
 - adding notes to events. *See* adding user-placed events, 2–23
 - cautionary notes, 2–1
 - cursor use, 2–15
 - event table screen, 2–11
 - file storage, printing, copying. *See* storage
 - high-density testing, 2–21
 - ON/OFF button, 2–4
 - printing files. *See* printing files
 - radiation exposure warning, 2–1
 - real-time testing, 2–21

SELECT button and arrow keys,
2-17

test procedure, 2-3

using a personal computer. *See*
personal computer

waveform screen defined, 2-8

when to check setups, 2-4

zoom window, 2-19

file

- deletion, 2-40
- loading onto screen, 2-36
- saving, 2-31
- storage, 2-31
- transfer (copying), 2-38

file content setup, 1-36

file format setup, 1-37

File Setup softkey, 2-32

floppy disk

- description, 1-3
- formatting, 1-4

flow control setup, 1-35

FMTAP software, 2-49

format menu

- descriptions, 1-25
- summary table, 1-12

front-panel functions, keyboard,
5-14

H

HP DeskJet, 1-35

HP LaserJet, 1-35

HP ThinkJet, 1-35

HELP button, 1-8

See also help information

help information, phone numbers/
address, xiii

high-density testing, 2-21

I

I/O-Doc menu

- descriptions, 1-34
- summary table, 1-14

index matching material, caution-
ary note, 4-1

Insert Char softkey, 2-27, 2-33

IntelliTrace mode, 1-19

J

join cursors, 2-16

K

keyboard connector

- description, 1-3
- specification, 5-5

keyboard definitions

- front-panel functions, 5-14
- text-entry functions, 5-13

keyboard translation setup, 1-32

L

language setup, 1-33

language

- power on default, 1-32

laser output port

- cautionary information, 1-3
- cleaning, 4-3
- cleaning/troubleshooting, 4-2
- location and description, 1-1
- options, 5-9
- safety information, ix
- specifications, 5-1

Load softkey, 2-37
loss delta setup, 1-28
loss scale, waveform screen, 2-8
loss setup, 1-27
loss tolerance setup, 1-28
low-battery warning, 3-1

M

Manual mode, 1-20
manual mode
 high-density testing, 2-21
 real-time testing, 2-21

O

ON/OFF button, 1-8
operating problems, insufficient
 battery charge, 4-7
optional accessories, 5-7
options
 connector adapter, 5-9
 instrument configuration, 5-10
 laser output port, 5-9

P

parallel port
 description, 1-3
 specifications, 5-5
personal computer
 file copying procedure, 2-51
 file transfer, 2-49
 FMTAP software, 2-49
 TDS software, 2-49
PostScript printer, 1-35
power, specifications, 5-3
power off time setup, 1-31
power on defaults
 language, 1-33

power on defaults setup, 1-33
power/charger adapter
 description, 3-2
 moisture warning, 3-2
 port description, 1-4
 power cord options, 5-8
 setup for recharging NiCad bat-
 tery, 3-3

Print All softkey, 2-48
print content setup, 1-35
Print Selected softkey, 2-48
printer setup, 1-35
Printer Setup softkey, 2-47
printing files, 2-43
 printer setup, 2-44, 2-47
 printers available, 2-43
 procedure, 2-45
 Seiko DPU411 switch setups,
 2-45
pulsewidth setup, 1-21

R

real-time testing, 1-8, 2-21
reflectance setup, 1-26, 1-27
reflectance threshold setup, 1-22
refractive index setup, 1-23
 how to calculate, 1-23
RS232C port, specifications, 5-3

S

safety
 beam properties, x
 information and precautions, ix
 laser radiation, ix
 optical output, x
 terms and symbols, xii
Save File softkey, 2-31
scan for setup, 1-22

- Seiko DPU411, 1–35
- SELECT** button, 1–7, 1–16, 2–10, 2–12, 2–17, 2–20, 2–22, 2–33, 2–47, 2–51
- Send All Files** softkey, 2–53
- Send Selected** softkey, 2–53
- serial port
 - See also* RS232C port
 - description, 1–3
- service information
 - See also* help information
 - cautionary message, 4–7
 - cleaning procedures, 4–3
 - fatal error code, 4–9
 - front panel connection status message, 4–8
 - no power on, 4–7
 - self test error message, 4–8
- Setup** softkey, 2–9
- setups
 - arrow keys, 1–16
 - auto increment, 1–37
 - averages, 1–21
 - backlight time, 1–31
 - baud rate, 1–34
 - company name, 1–36
 - contrast adjust, 1–31
 - cumulative loss, 1–28
 - cursor A-B, 1–26
 - date, 1–32
 - date format, 1–32
 - dead zone, 1–28
 - distance, 1–27
 - distance delta, 1–29
 - distance tolerance, 1–29
 - distance units, 1–24
 - end of fiber mode defined, 1–20
 - end of fiber threshold, 1–22
 - event, 1–25
 - external port, 1–35
 - fiber scan, 1–19
 - file content, 1–36
 - file format, 1–37
 - flow control, 1–35
 - Format menu descriptions, 1–25
 - Format menu summary table, 1–12
 - how to change, 1–15
 - I/O–Doc menu, 1–34
 - I/O–Doc menu summary table, 1–14
 - Intellitrace mode defined, 1–19
 - keyboard translation, 1–32
 - language, 1–32
 - loss, 1–27
 - loss delta, 1–28
 - loss tolerance, 1–28
 - manual mode defined, 1–20
 - power off time, 1–31
 - power on defaults, 1–33
 - print content, 1–35
 - printer, 1–35
 - pulsewidth, 1–21
 - quick overview, 1–18
 - reflectance, 1–26, 1–27
 - reflectance threshold, 1–22
 - refractive index, 1–23
 - scan for, 1–22
 - setup menus defined, 1–9
 - Setup** softkey, 1–9, 1–15
 - setup summary tables, 1–11
 - slope, 1–27
 - sound, 1–31
 - splice loss, 1–26
 - splice threshold, 1–22
 - System menu descriptions, 1–30
 - System menu summary table, 1–13
 - Test menu descriptions, 1–19
 - Test menu summary table, 1–11
 - test port, 1–24
 - test range, 1–20

- time, 1–32
- slope setup, 1–27
- softkeys
 - general description, 1–8
 - Setup**, 1–9
- sound setup, 1–31
- specifications
 - environmental, 5–5
 - keyboard connector, 5–5
 - laser output port, 5–1
 - parallel port, 5–5
 - power, 5–3
 - RS232C port, 5–3
 - size and weight, 5–3
- splice loss setup, 1–26
- splice threshold setup, 1–22
- standard accessories, 5–7
- START/STOP** button, 1–8, 2–5, 2–21
- storage
 - copy option, 2–38
 - delete option, 2–40
 - load option, 2–36
 - options, 2–29
 - procedure, 2–31
 - save option, 2–31
- Store or Print** softkey, 2–9
- system menu
 - descriptions, 1–30
 - summary table, 1–13

T

- table option, 2–18
- Table/Trace** softkey, 2–5, 2–9, 2–12
- TDS software, 2–49, 2–52
- Tektronix, factory address and phone numbers. *See* help information

- test menu
 - descriptions, 1–19
 - summary table, 1–11
- test port setup, 1–24
- test range setup, 1–20
- text entry, 2–33
- time setup, 1–32
- trace option, 2–18
- troubleshooting
 - cautionary message, 4–7
 - fatal error code, 4–9
 - front panel connection status message, 4–8
 - no power on, 4–7
 - self test error message, 4–8

U

- Undo** softkey, 2–24, 2–27, 2–33

V

- View Notes** softkey, 2–47

W

- warranty information, xiv
- waveform
 - moving the waveform, 2–18
 - zooming, 2–18
- waveform screen, 2–8

Z

- Zoom On/Off** softkey, 2–10, 2–20, 2–22
- zoom option, 2–18

zoom window
defined, 2-19

zoom procedure, 2-20

